

EVALUATION OF DC-DC CONVERTERS USED WITH PHOTOVOLTAIC SYSTEMS

Dina S. M. Osheba*

Hytham Z. Azzazi*

S. S. Shokralla*

Faculty of Engineering, Shebin El-Kom - Menoufiya University

ABSTRACT

This paper presents theoretical and experimental evaluation of DC-DC converters used with photovoltaic (PV) power systems. Criteria for converters used with PV systems are discussed and a fairly detailed simulation of a PV system which includes different types of DC-DC converters is built. The simulation is used to assess the performance of the most common DC-DC converters over a wide range of loads, irradiation levels and duty ratios. The presented simulation results are verified experimentally using a DSP-based laboratory system. The results illustrate clearly that the range of change in converter duty ratio to operate at maximum power point is smaller with Cúk converter which leads to more reliable and stable operation of PV system with Cúk converter. This result is, also, of prime importance to power system engineers forming a useful guide to design and operate PV systems at maximum power point without additional complexity, leading to the design reliable and low cost PV system for remote areas, rural villages and desert development applications.

Keywords: Solar Cells, DC-DC Converter, Cúk Converter, Sepic Converter, Photovoltaic generators, DC-Motor

يعرض هذا البحث تقييم أداء محاولات التيار المستمر المستخدمة مع منظومة طاقة ضوئية نظريا وعمليا . تم الحصول على النموذج الرياضي غير الخطي للمنظومة مع أخذ كل حالات التشغيل للمحوال في الاعتبار وتم محاكاة المنظومة مع أحمال مختلفة. تم عرض النتائج النظرية والعملية موضحة حالات التشغيل المستقر والعاير . توضح النتائج ان تشغيل منظومة الطاقة الضوئية يكون اكثر استقرارا مع محوالم Cúk حيث يكون مدى تغيير نسبة التشغيل (duty ratio) للوصول الى اقصى قدرة عند كل نسب الاشعاع متقارب ما يجعل تشغيل المنظومة اكثر استقرارا وملائمة مع محوالم Cúk لمدى واسع من الاشعاع الشمسى وتوضح النتائج انه بالتصميم الجيد لمولد الطاقة الضوئية والاختيار المناسب لعناصر المحوالم يمكن تحسين أداء منظومة الطاقة الضوئية والحصول على أقصى قيمة لتحويل الطاقة بدون تعقيدات اضافية للنظام مما يساعد على بناء نظام طاقة ضوئية رخيص للمناطق الريفية والتطبيقات الصحراوية .

1- INTRODUCTION

There is a worldwide agreement on the need to reduce greenhouse gas emissions. Different policies are implemented both internationally and locally regarding this matter [1,2]. One of the vital components in the achievement of this goal is the intention to provide a high share of energy obtained from renewable sources worldwide. Also, the limited sources of conventional energy and the ever-increasing energy consumption renders the search for new sources of energy an urgent matter. It is believed that between the years 2020 and 2030, a major "energy gap" will arise between the required amount of energy and what can be produced from fossil fuels. To resolve this energy gap, new energy sources will be needed. Among these new energy sources, photovoltaic power generation holds particular promise as it is green, unlimited and is available anywhere in the world.

The photovoltaic is considered an electric source for non-space applications after the oil crisis in 1973.

Intensive research plans financed by photovoltaic authorities and incentive programs to encourage the use of photovoltaic energy over the past 40 years led to a substantial reduction in solar cell production cost and enormous increase in solar cell efficiency [3].

There are two major sectors for the use of photovoltaic systems, grid-connected and stand-alone systems. The former delivers power directly to the grid as the dc current from the solar modules is converted into ac by an inverter. The latter supplies power to decentralized systems and small-scale consumer products. A major use of PV systems being currently developed is in solar home systems, supplying basic electricity demand of rural population in developing countries and many other application systems in remote areas. This, however, requires that such loads are supplied via a DC-DC converter to match the load voltages especially dynamic loads[3]. However, the role of duty ratio setting is of prime importance to operate at maximum power point

The work described in this paper is part of a project initiated in Menoufiya University, Egypt with the objective of analyzing the performance of AC and DC loads when fed from PV sources. Also, the project aims to substitute for the lack of conventional energy, increasing solar energy share and producing economical and reliable PV systems for remote areas, rural villages and desert development. This paper present a theoretical and experimental evaluation of the DC-DC converters used with PV systems [3].

2. DC – DC Converters

The output voltage of the PV array continuously change due to the varying nature of solar irradiation[4-8]. This and the nonlinear characteristics of PV arrays require that DC-DC ensures constant voltages at the load terminals when closed loop systems are being considered. Also, the DC-DC converters are also an important element in the PV system, enabling the design of maximum power trackers to track the maximum power point at different irradiation levels [9, 10].

2.1 Buck Converter

The buck converter is known as a dc-dc step down converter. The di/dt of the load current is limited by an inductor. However, the input current is discontinuous and a smoothing input filter is normally required. It requires a protection circuit in case of a possible short circuit across the diode path.

2.2 Boost Converter

A boost regulator can step up the output voltage without using a transformer. The input current is continuous. However, a high peak current has to flow through the power switch. The output voltage is very sensitive to changes in duty ratio and it might be difficult to stabilize the regulator.

2.3 Buck-Boost Converter

A buck–boost regulator provides voltage polarity reversal without a transformer under fault condition of the transistor and has a step up/down capabilities. However, the di/dt of the load current is limited by an inductor. Output short circuit protection would be easy to implement. However, the input current is discontinuous and a high peak current flows through the power switch. Both the input and output currents are highly discontinuous which Leads to large external filtering requirements

2. 4 Cúk converter

The Cúk converter is a type of dc-dc that has step up/down capabilities with an inverted output. The Cúk converter is based on the capacitor energy transfer. As a result, the input current is continuous. The circuit has low switching losses and has high efficiency. The output voltage is reversed (opposite of the input voltage). The output voltage may be more or less than the input voltage. Thus it operates

in both buck and boost mode which depends upon the duty–ratio. The advantage of the Cúk circuit is that both the input current and the current feeding the output stage are reasonably ripple free. This advantage translates in terms of low filtering requirements on both sides.

2.5. Sepic Converter

It is also known as single-ended primary-inductor converter which is a type of dc-dc converters similar to the Cúk converter but has advantages of having non-inverted output i.e. the output voltage is of the same polarity as the input voltage.

3 - SYSTEM DESCRIPTION

Figure 1 shows the PV system considered in this study. It consists of the PV array which includes 6 modules with the possibility of having different external connections to get the required output voltage and current. The PV array is connected to the load via a DC-DC converter. The most commonly used three different types of DC-DC converters have been considered; Boost, Cúk and Sepic Converters. The circuit diagrams of these converters are shown in Figure 2.

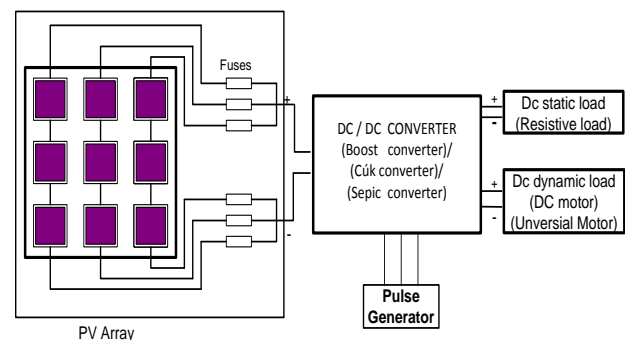
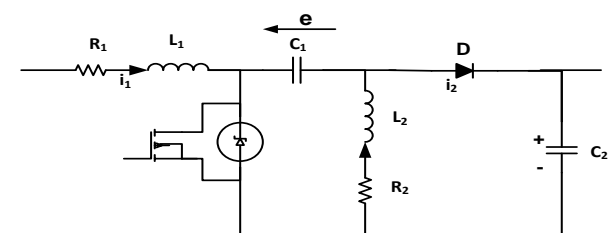
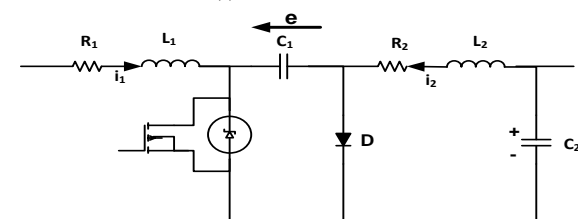

Fig.1 Schematic Diagram of the PV system



(i) Boost Converter



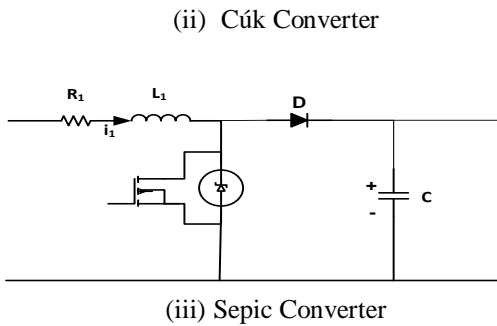

Fig. 2 Circuit diagram of DC-DC Converter

4. SIMULATION RESULTS

The system is simulated using MatLab SimScape PV cell standard model[8]. The PV simulation model is shown in Figure 3.

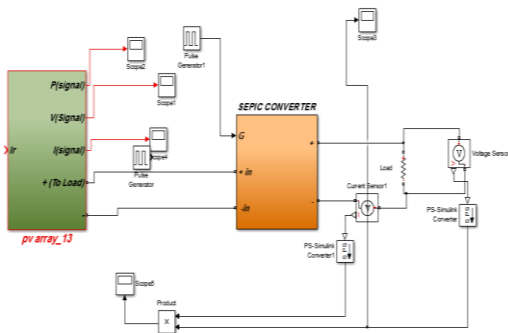

Fig. 3 : MatLab Simulation PV System Model

4.1. Power Voltage characteristics

Initially, the power voltage characteristics of the PV array have been measured for a single module, two parallel and two series modules. An optimization technique is then used to estimate the array parameters and an agreement between measured and simulated characteristics were obtained at an irradiation level $I_r = 1000 \text{ W/M}^2$. The simulation is then used to predict the power voltage characteristics over a wide range of irradiation levels as shown in Figure 4. The analysis of these results which are confirmed experimentally illustrates that a difference of maximum power (MPP), between $I_r = 200 \text{ W/M}^2$ and $I_r = 1200 \text{ W/M}^2$ is very limited as shown in Table1. The voltage at MPP varies between 32.01 volt at 1200 W/M^2 and 30.55 volt at 200 W/M^2 . This is shown in Table 1. This result is of prime importance to PV system designers as it enables them to design low cost PV systems by adjusting the DC-DC converter duty ratio within limited range. Therefore, a comprehensive assessment of the effects of duty ratio is required.

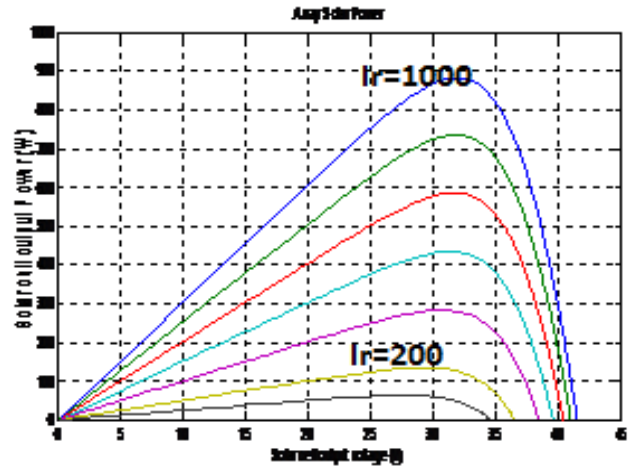

Figure:4 Solar Power variation versus Voltage at different I_r

Table 1: Voltages at MPP with different irradiation

I_r	1200	1000	800	600	400	200
P_{max}	882.8	734.9	585.6	434.7	283.8	135.13
V_{mp}	32.10	32.09	31.58	31.54	30.95	30.55
I_{mp}	880	733	584	434	282.5	130

4.2 Effects of Converter Duty ratio

Figure 5 shows variation of PV power versus duty ratio for boost and Cúk converter. These results were obtained at load resistance = 28 Ohm

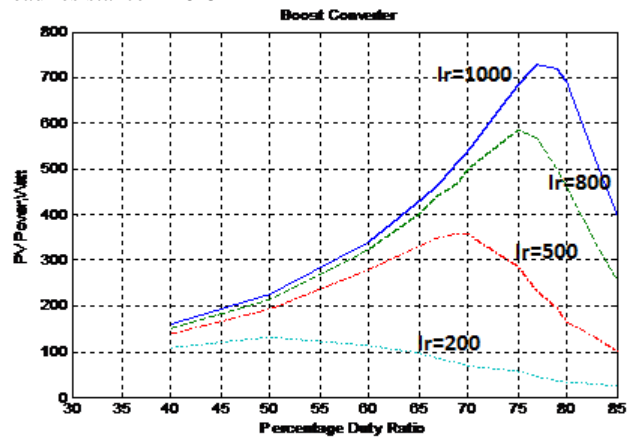

(i) Boost DC-DC converter

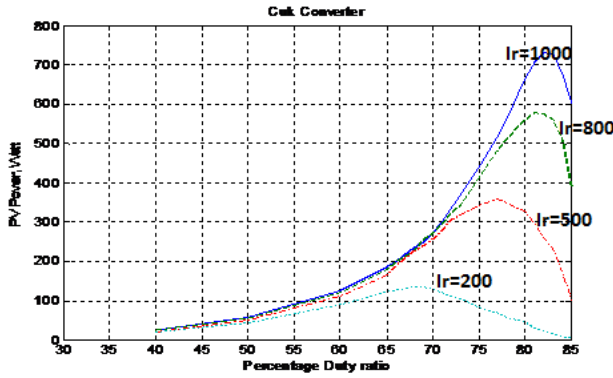

(ii) Cúk DC-DC converter

Figure 5: Variation of PV Power versus duty ratio

These results illustrate that for boost converter maximum power point D_{mpp} varies between 50% and about 80%, while it varies between 70% and 80% for Cúk converter. Variation of duty ratio for Sepic converter was found to be similar to Cúk converter. Further analysis illustrated the duty ratio at maximum power point D_{mpp} is also affected by system loads as shown in Table 2. This is also confirmed by the results shown in a comparative form for Boost, Cúk and Sepic converters at $I_r = 1000W/M^2$ and load resistance = 5 Ohm in Figure 6. These results confirm that D_{mpp} is significantly affected by loads and without using a Maximum power point tracking technique careful attention should be given to the adjustment of the duty ratio. This is essential to extract maximum power, or even near maximum power, from the system. This becomes of prime importance for using PV system in remote and rural areas which requires less complicated systems and the cost becomes an important factor for using such systems.

Table 2 PV Power versus D_{mpp}

Converter Type	Load Resistance			
	6 Ω	12 Ω	18 Ω	28 Ω
% D_{mpp} (Boost)	51	65	72	77
% D_{mpp} (Cúk)	70	75	79	81
% D_{mpp} (Sepic)	74	78	81	83

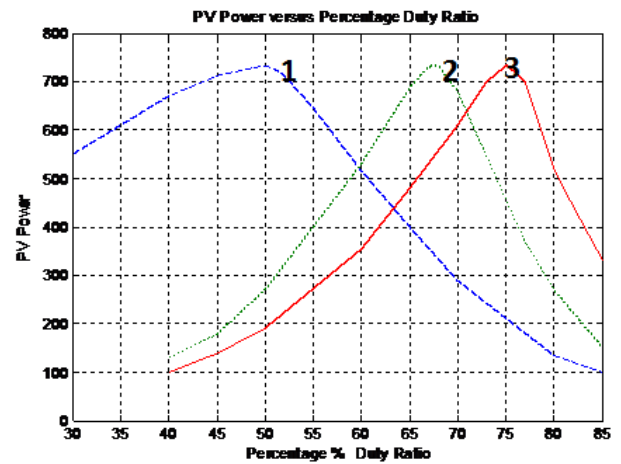
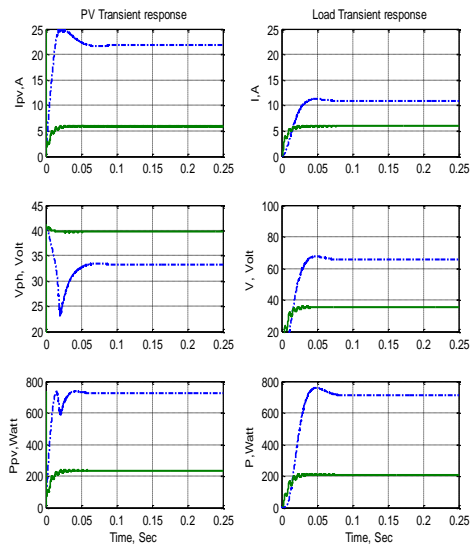

Fig. 6 : Power variation at R=5 Ohm and $I_r = 1000W/M2$
1= Boost , 2= Cúk 3= Sepic Converter

4.3 Transient response

To further prove the above remarks, the PV system is operated with the boost and Cúk converter at $I_r=1000 W/M^2$ and Duty ratio, $D= 50\%$ as shown in Fig.7.i in a comparative form. This results illustrate better performance of boost converter over Cúk converter. This is due to the fact that the value of $D=50\%$ represents D_{mmp} for boost converter and is much less than D_{mmp} of Cúk converter. This test is then repeated at $D=70\%$ which is nearly equal to D_{mpp} for Cúk converter and greater than that for boost converter as shown in a comparative form in Fig. 7.ii. The results illustrate that better performance of Cúk over that for the boost converter. This illustrates that adjusting the duty ratio to that near D_{mpp} is crucial in PV systems to extract maximum power. Moreover, power variation is very sensitive for boost converter than that of Cúk converter. It can be observed that adjusting the duty ratio for Cúk converter to about 75% will be suitable for most loads. This may be reduced to 70% for heavy loads and increased to 80% for small loads. This conclusion is not applicable for boost converter as the duty ratio varies over the whole range i.e. from 50% to 80% which is wider than that of Cúk converter. This makes the Cúk converter more suitable for PV systems.



(i) Duty ratio =50%, R=6,

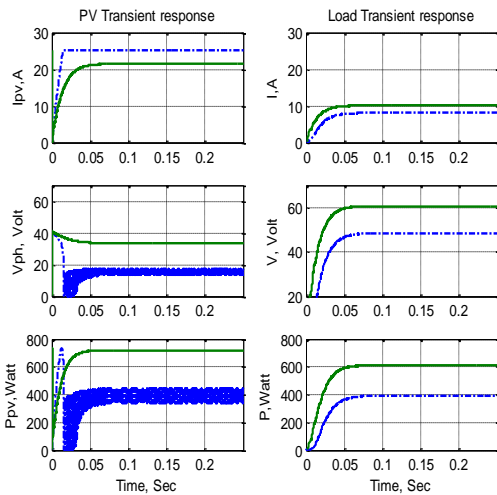

(ii) Duty ratio = 68%

Figure 7 : Response of PV system at D=68%, R=6,
 - - - Boost Converter
 — Cúk Converter

5. Experimental Results

5.1 Installation of the PV Array

The PV array consists of 6 modules (Model PX 170) . Each module has 72 series cells and the simulation considered the possibility of various module connections so that any required voltage can be obtained. The modules have been fixed after comprehensive measurements of solar irradiation. Figure 8 shows the measurements of solar irradiation in two days which illustrate the effect of shading on solar irradiation.

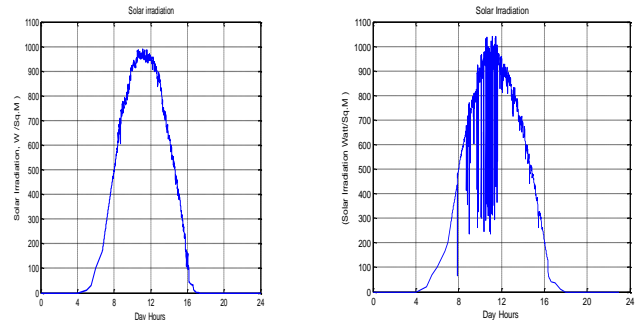

(i) Sunny day (ii) Cloudy day
 Figure 8 Measured Solar irradiation Characteristics

Figure 9 shows the effects of tilt angle on irradiation level. The effect of the tilt angle on the output power and daily energy is also shown Figure 10. These measurements are used to install the PV array as shown in Figure 11.

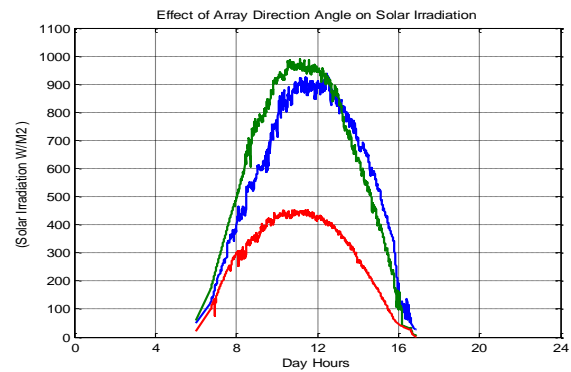

Figure 9: Effect of tilt angle on solar Irradiation

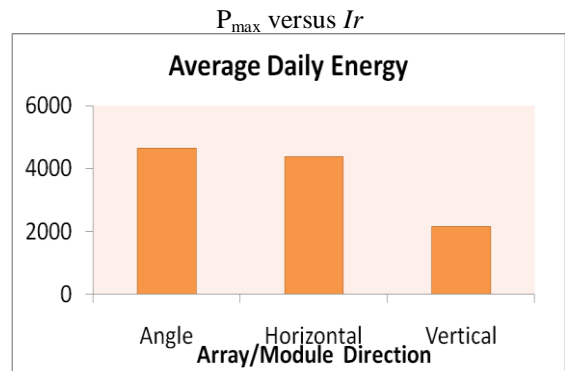
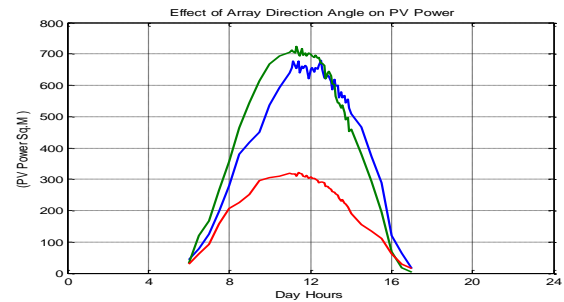

Figure 11 Effect of Tilt angle on Pmax



Figure 11: Installation of PV array

5.2 Experimental set up

Figure 9 shows the DSP-based Laboratory system. The PV array, shown in Figure 12, consists of 6 modules (Model SUNSET PX 170) which are connected to the load via a DC converter as shown in the figure. Measurements are recorded and algorithms have been implemented using the DSP controller board DS1104 with the necessary drive circuit and transducers. The DSP board is placed in the PCI slot of the PC, with uninterrupted communication through dual port memory. IGBT is used as a switch which requires appropriate voltage so that the IGBT is driven into the saturation for low on-state voltage. A drive circuit is used to generate a pulse with a proper voltage level for the IGBT. This is due to that the outputs of the digital I/O subsystem of the DSP board (DS 1104) are pulses having magnitude of 5 V which is not sufficient to drive the gate of IGBT.

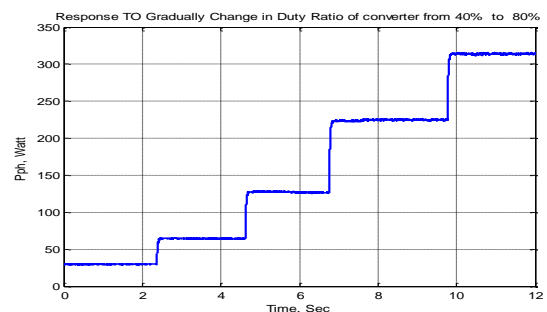
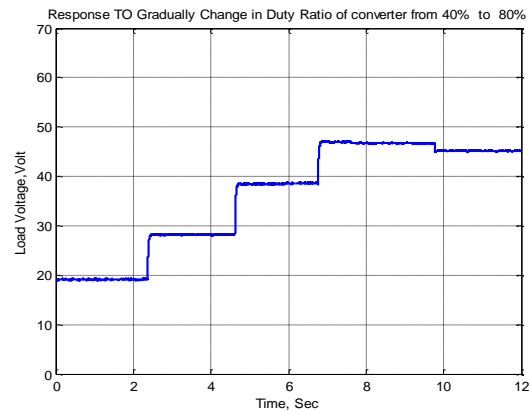
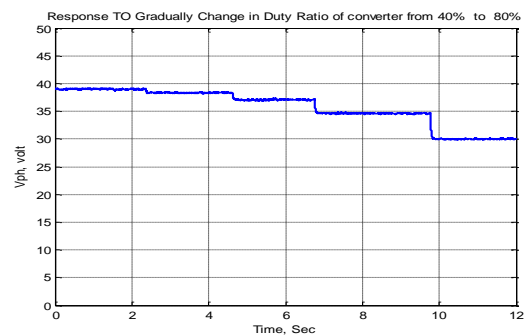
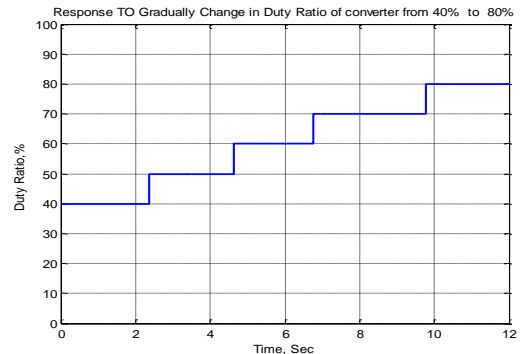

Figure 12: DSP-based PV System

5.2 Performance of Static Load

The load is connected to the PV system via the Cúk converter with only three parallel modules. The DSP is programmed to generate gate pulses so that 10% gradual increase in duty ratio occurs as shown in Figure 13. These pulses are inputted to the drive circuit which generates the gate voltage required for the IGBT and the results are shown in Figure 13. The results clearly confirm that the PV starts to supply power to the load which is increased gradually as the duty ratio increases. The PV voltage decreases and the load voltage increases with the increase of duty ratio as shown in Figure 10. As the duty ratio reaches 70% the PV supplies maximum load as the PV voltage reaches that at MPP and this is confirmed by

the starting decrease in load voltage. This is also clear by examining the results Table 1. Also the load voltage starts to decrease confirming that the PV reaches its maximum value as might be extracted from Figures 5 and 7.



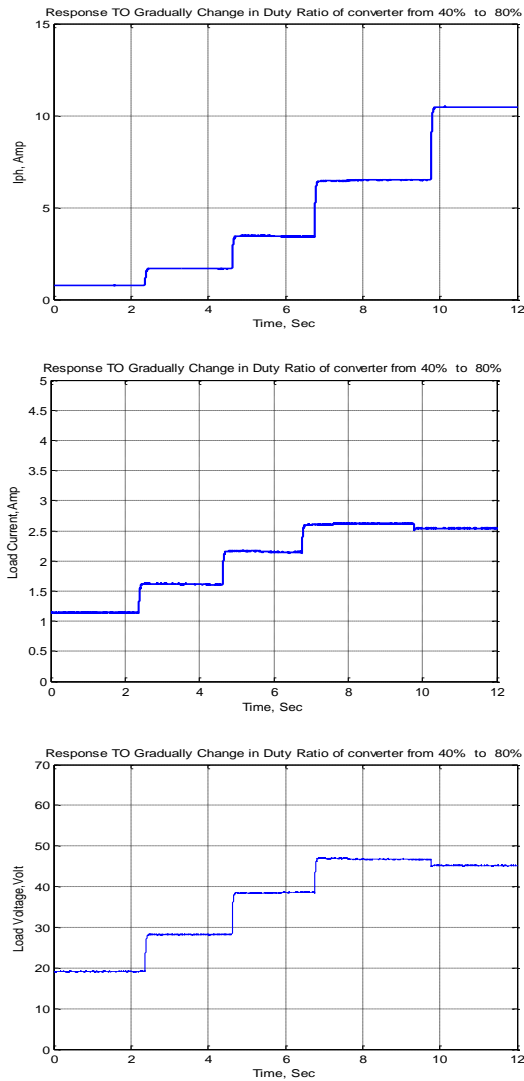

Figure 13: Response to a gradual increase in duty ratio

CONCLUSION

The paper presented theoretical and experimental assessment of boost, Cúk and sepic converters when used with a PV array to supply DC loads. The range of the Cúk converter duty ratio which enables the system to work at MPP is limited in comparison with other DC-DC converters. The results illustrate reliable and stable of the cuk converters. This enables the user to easily set the duty ratio at a specific value to enable the maximum or even near the maximum power point without additional system complexity. This conclusion is of prime importance leading to the design of simple low cost PV systems which operate near maximum power point for remote areas and desert applications.

REFERENCES

[1] A. Goetzberger and V.U. Hoffmann : "Photovoltaic SolarEnergy Generation", ISBN 3-540-23676-7 Springer Berlin Heidelberg New York, 2005

[2] LeonFreris and DavidInfield : "Renewable Energy in Power Systems", ISBN978-0-470-01749-4, AJohn Wiley&Sons, Ltd, Publication,2008

[3] Osheba, D. S. M.,: "Photovoltaic System Fed DC Motor Controlled By Converters", M.Sc Thesis, Department of Elect.Eng. Menoufiya Uni.2010.

[4] Gow J. A and Manning C. D. , : "Development of a photovoltaic array model for use in power electronics simulation studies, IEE Proc. Electr. Power Appl., Vol. 146, No.2, March 1999

[5] Enrique, J.M. ; Duran, E. ; A new approach to obtain I-V and P-V curves of photovoltaic modules by using DC-DC converters",IEEE Photovoltaic Specialists Conference, 2005, pp 1769-1772

[6] Brian Goss, et al ,:"Irradiance modeling for individual cells of shaded solar photovoltaic array ", Solar Energy, Vol 110,pp 410-419, 2014.

[7] Garcia A. M. , el al ;: "A New Solar Module Modeling for PV Applications Based on a Symmetrized and Shifted Gompertz Model" IEEE Transactions On Energy Conversion, pp 1-9,2014-11-09

[8] H. Patel and V. Agarwal, "Matlab-based modeling to study the effects of partial shading on PV array characteristics," IEEE Trans. Energy Convers., vol. 23, no. 1, pp. 302–311, Mar. 2008.

[9] Cristaldi, L. et al : "An Improved Model-Based Maximum Power PointTracker for Photovoltaic Panels", IEEE TRANSACTIONS ON INSTRUMENTATION AND MEASUREMENT, VOL. 63, NO. 1, JANUARY 2014

[10] Z. Liang, R. Guo, J. Li, and A. Q. Huang, "A high-efficiency PV module-integrated DC/DC converter for PV energy harvest in FREEDM systems," IEEE Trans. Power Electron., vol. 26, no. 3, pp. 897–909, Mar.2011.

[11] Loredana Cristaldi et al , : "An Improved Model-Based Maximum Power Point Tracker for Photovoltaic Panels ",IEEE TRANSACTIONS ON INSTRUMENTATION AND MEASUREMENT, VOL. 63, NO. 1, JANUARY 2014