

Investigation of the Axial Rotor Thrust in Centrifugal Compressors

استقصاء الدفع المحوري على العضور الدوار فى الضواغط النابذة

Aly M.Elzahaby¹, S.A.El-Agouz¹, Ahmed Farid Nemnem², Abdelhady Abelzain Mubarak³

1 Mechanical Power Engineering Dep. Faculty of Engineering, Tanta University, Egypt.

2 Military Technical College, Egypt.

3 Mechanical Engineer in Abu Qir Fertilizer Comp., Egypt, E-mail: Abdelhady.abdelzine@yahoo.com

الملخص

الهدف من البحث هو دراسة وتحليل والتعنين الدقيق للدفع المحورى على العضو الدوار فى الضواغط الطاردة المركزية. نشرح العوامل التى تؤثر على الدفع المحورى مثل زيادة الأحمال على ضاغط ثانى أكسيد الكربون عن أوضاع التشغيل التصميمية له. كما تتضمن العوامل تأثير وجود Fouling مع الغاز مما ينتج عنه تراكم على الأسطح الداخلية لدفاعات العضو الدوار فيتسبب فى زيادة الدفع المحورى وتقليل من أداء الضاغط. يتناول البحث شرح العلاقة ما بين الدفع المحورى للعضو الدوار فى وجود نسبة Fouling مع الغاز فى خلال فترة زمنية محددة من بعد عمل عمرة كاملة لضاغط ثانى أكسيد الكربون. بعد الدراسة والتحليل نقف على كيفية تقليل الدفع المحورى على العضو الدوار وذلك بوضع اسطوانة اتزان على العضور الدوار لخلق قوى معاكسة له تتناسب مع جميع الظروف التشغيلية لضاغط ثانى أكسيد الكربون بحيث أن الدفع المحورى للعضو الدوار بعدها لا يتعدى 50 % من حمل الكرسى. النتائج النهائية التى تم الحصول عليها: عند استخدام قطر اسطوانة اتزان $D_t = 158.6686$ mm تكون أعلى قيمة للدفع المحورى عن أوضاع التشغيل المختلفة للضاغط هى 93.193 % من حمل الكرسى. عند استخدام قطر اسطوانة اتزان $D_t = 186.065$ mm تكون أعلى قيمة للدفع المحورى عن أوضاع التشغيل المختلفة للضاغط هى 73.35 % من حمل الكرسى. عند استخدام قطر اسطوانة اتزان $D_t = 174.595$ mm تكون أعلى قيمة للدفع المحورى عن أوضاع التشغيل المختلفة للضاغط هى 41.22 % من حمل الكرسى مع وجود Fouling مع الغاز وعند أقصى حمل للضاغط بعد العمرة فى عدم وجود Fouling مع الغاز هى 0 % من حمل الكرسى وهذا يعتبر أنسب قطر يستخدم لاسطوانة الاتزان (Balance drum) لأن الدفع المحورى يكون أقل من 50 % من حمل الكرسى.

Abstract: This article is a study, analysis, and determine accurately the axial rotor thrust for centrifugal compressors. Are explained the factors that affect axial rotor for carbon dioxide compressor during operating conditions. Also, the effect of the existence of fouling with gas, results in the accumulation of fouling on the internal surfaces of the impellers leading to an increase in axial rotor thrust and reduction of the performance of the compressor. The relationship between axial rotor thrust and fouling ratio with time is discussed after complete overhaul for the carbon dioxide compressor. The axial rotor thrust on the carbon dioxide compressor is reduced by placing balance drum on rotor of the compressor in the opposite direction of the axial force which is suitable for all operating conditions of the compressor. The resultant axial force didn't exceed 50 % of rated bearing load, and the analysis method is then approved to be effective. The residual thrust load for high pressure rotor for the compressor before modification at design operating condition is equal to 13.68 % of rated bearing load, while at the high load without fouling effect for the compressor is equal to 58.47 % of rated bearing load and compressor with fouling effect is equal to 110.9 % of rated bearing load. When using the balance drum diameter $D_t = 158.6686$ mm, the highest value of axial thrust force is equal to 93.193 % of rated bearing load. When using the balance

drum diameter $D_t = 174.595$ mm, the highest value of axial thrust force is equal to 41.22 % of rated bearing load. When using the balance drum diameter $D_t = 186.065$ mm, the highest value of axial thrust force is equal to 73.35 % of rated bearing load.

I. INTRODUCTION

Accurate analysis of axial rotor thrust during preliminary design has a decisive effect on the final configuration of centrifugal compressor including layout of thrust bearing, fluid leakage, rotor dynamics and aero – thermodynamic performance. An incorrect layout of thrust bearing resulting from wrong or insufficient analysis can lead to compressor performance reduction due to unacceptable bearing high temperature and /or compressor damage due to bearing damage due to overload. Several design arrangements are introduced to decrease axial thrust, “eg. back to back” instead of “in – line” for the multistage compressor, thrust brakes, stage inlet geometry, balancing drum and balancing holes.

Axial thrust in centrifugal compressor is basically generated by pressure imbalance across impeller acting in the opposite direction of the incoming flow in the eye. Thus the rotor is subjected to a great force trying to move it against the direction of the incoming flow. The carbon dioxide compressor Problem is explained that increase of the axial rotor thrust lead to thrust bearing failure more than once. Thrust bearing failure due to increase in the load on the compressor bearing more than the design operating conditions and fouling effect. Zhangling et al. [11], [12] axial rotor thrust balancing by using balance drum. Pavlenko [13] explain the multistage centrifugal compressor with automatic balancing device. Boumann et al. [14] explain the thrust brakes effect on centrifugal compressor.

The present work is how to reduce the axial rotor thrust on the carbon dioxide compressor by placing balance drum on rotor compressor in opposite direction of the axial force.

II. METHODOLOGY THRUST LOADS CALCULATION

During operating the rotor of a centrifugal compressor is subjected to an axial thrust “F” resulting from the sum of several components [1], [2], [3].

A. Momentum Thrust F_M

Momentum thrust force is caused by the variation of

moving gas as it enters the impeller axially and leaves it radially as shown in Fig. 1.

$$F_M = \frac{m^2}{\rho A} \quad [N] \rightarrow (1)$$

where:

m is gas mass flow rate, [kg / s]

ρ is gas density at impeller inlet, [kg / m³]

A is impeller inlet area, [m²]

$$A = \frac{\pi(D_6^2 - D_4^2)}{4}$$

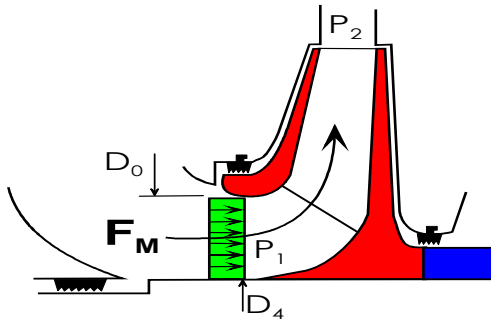

Fig. 1: Scheme for determination of momentum thrust

B. Inlet Thrust F_I

This force results from distributed pressure acting on the impeller eye as shown in Fig. 2.

$$F_I = P_1 \frac{\pi(D_m^2 - D_{8p}^2)}{4} \quad [N] \rightarrow (2)$$

where:

p_1 is impeller inlet pressure, [bar a]

p_2 is impeller outlet pressure, [bar a]

$D_m = 0.5(D_5 + D_6)$, [m]

D_{8p} is Diameter under end shaft labyrinth seal, [m]

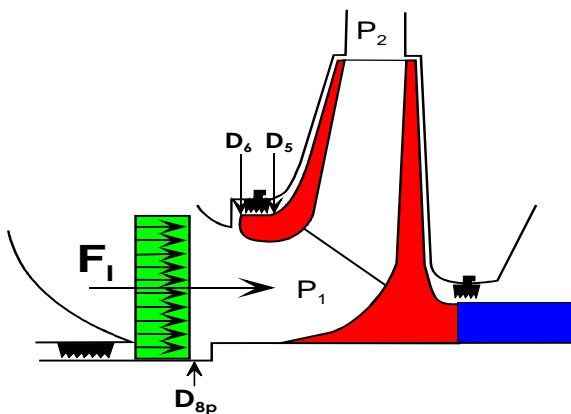

Fig. 2: Scheme for determination of inlet thrust

C. Shroud Thrust F_S

This force results from pressure acting on the shroud outer surface as shown in Fig. 3.

$$F_S = P_2 \frac{\pi(D_{tip}^2 - D_m^2)}{4} \quad [N] \rightarrow (3)$$

D. Hub Thrust F_H

This force results from pressure acting on the hub outer surface as shown in Fig.4.

$$F_H = P_2 \frac{\pi(D_{tip}^2 - D_8^2)}{4} \quad [N] \rightarrow (4)$$

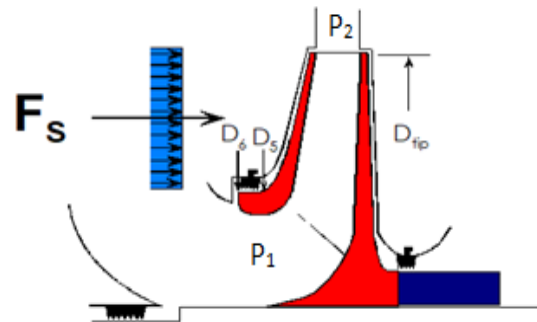

Fig. 3: Scheme for determination of shroud thrust

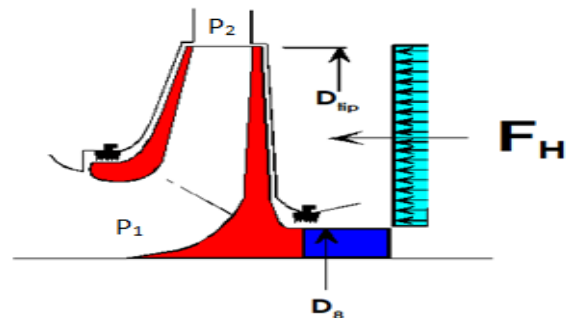

Fig. 4: Scheme for determination of hub thrust

E. Secondary Effect F_{SE}

Secondary thrust results from the irregularity of pressure acting on the impeller as shown in Fig.5. This thrust is strongly influenced by many factors such as friction coefficient between gas and impeller material and geometry of surfaces. This type of thrust force is based on some factors collected in literature and confirmed by experience.

$$F_{SE} = A_{average} \times K \times \Delta P \times n^* \quad [N] \rightarrow (5)$$

$$A_{av.} = 0.5 \times \frac{\pi}{4} \times \{ (D_{tip}^2 - D_m^2) + (D_{tip}^2 - D_8^2) \} \quad [m^2] \rightarrow (6)$$

where:

K is surface factor from data sheet

n^* is (No. of impellers -1)

$A_{av.}$ is average area of phase, [m²]

$\Delta P = p_d - p_s$, [bar a]

p_s = Stage suction pressure, [bar a]

p_d = Stage discharge pressure, [bar a]

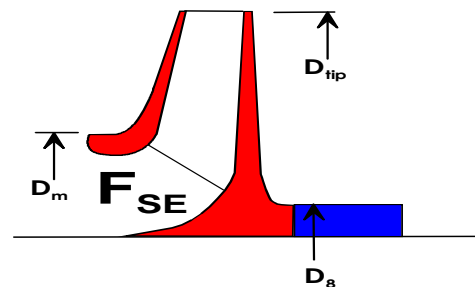

Fig. 5: Scheme for determination of secondary effect thrust

F. Compensator Thrust F_{Comp} .

Compensator thrust force results from providing a balance drum after the last impeller, placing its opposite face under suction pressure and sizing its diameter adequately. A thrust force is generated from suction to discharge side as shown in Fig.6. Thus compensator thrust is generated to balance the thrust coming from impeller. Residual thrust has to be taken up by a thrust bearing to keep the rotor at a certain position axially. In general terms, residual thrust in specified operating conditions is less than 50 % of thrust bearing maximum allowable load.

$$F_{Comp.} = \frac{\pi}{4} \times \{P_o(D_t^2 - D_{vt}^2) - P_{mc}(D_t^2 - D_{mt}^2)\} \quad [N] \rightarrow (7)$$

where:

P_o is static reference pressure for balance drum.

P_{mc} is static pressure upstream balance drum.

D_{vt} is seal diameter downstream balance drum.

D_{mt} is seal diameter upstream balance drum.

D_t is the balance drum diameter.

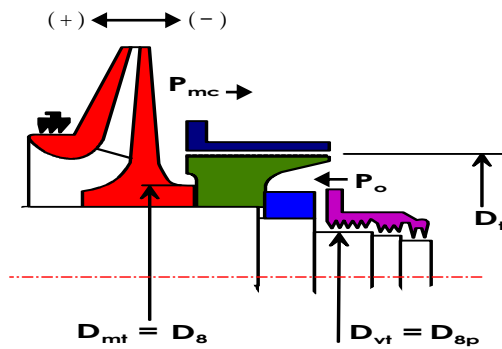

Fig. 6 Scheme for determination of compensator thrust

G. Residual Thrust F

It is the sum of all previous thrust forces.

$$F = F_I + F_M + F_{Comp.} + F_S - F_H - F_{SE} \quad [N] \rightarrow (8)$$

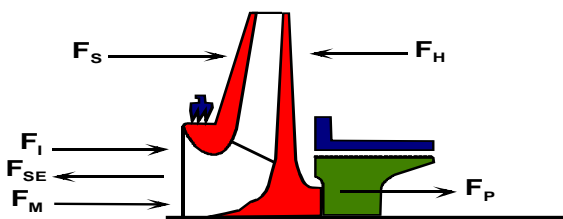

Fig.7 Scheme for determination of total thrust forces

III. MODEL DESCRIPTION

CO2 compressor consists of low pressure casing (Nuovo pingnone type 2 MCL 607) and high pressure casing (Nuovo pingnone type 2BCL 306/A) without balance piston as shown in Fig.8. Low pressure casing contains

two stages 1st stage and 2nd stage, high pressure casing contains two stages 3rd stage and 4th stage. CO2 compressor is equipped with an extraction condensing turbine (siemens manufacturing) with inlet steam conditions ($P = 107$ bar abs, $T = 505^\circ\text{C}$) and steam capacity (82.5 ton/h), operating speed (7050 R.P.M). Extraction steam flow from the turbine is supplied to urea plant with (64.6 ton/h, 24.5 bar abs, 320°C). The low pressure casing connected through a speed increasing gear box which increase speed from low pressure casing (7050 R.P.M) to high pressure casing (13500 R.P.M).

Gas, going to suction of compressor unit at pressure of 1.18 bar abs and a temperature of 40°C , is compressed at a final pressure of 142.16 bar abs with flow 25600 nm³/h through four compression stages (with inter stage cooler) as shown in Fig.8. Values of pressure and temperature after each compression stage (rated conditions) are shown in Table 1.

TABLE 1
DESIGN OPERATING CONDITION FOR THE CO2 COMPRESSOR

Compressor stages		1 st Stage	2 nd Stage	3 rd Stage	4 th Stage
Suction pressure	Bar abs	1.18	5.02	20.85	75.24
Discharge pressure	Bar abs	5.32	22.15	77.2	142.16
Suction temperature	°C	40	44	44	55
Discharge temperature	°C	204	214	208	125
Flow	nm ³ /h	25600			

A. Carbon Dioxide Compressor Problem Explanation

The increase of the axial rotor thrust for the high pressure casing led to thrust bearing failure more than once as shown in Fig. 9 due to two main reasons in the following:

- High Load of Compressor Effect

Flow during the compressor increased from 25600 nm³/h to 29000 nm³/h, suction pressure was increased from 1.18 bar abs to 1.45 bar abs and discharge pressure was increased from 142.16 bar abs to 145 bar abs. This was done by added a CO2 blower on compressor suction, led to increased axial thrust force on high pressure rotor from 7.3821 kN (13.68 % of rated bearing load = 53.955 kN) to 31.547 kN (58.47% of rated bearing load = 53.955 kN).

- Fouling Effect on the Axial Rotor Thrust with Time

Due to problems in CO2 removal unit, potassium carbonate in the CO2 gas inlet is deposited on CO2 compressor impellers that enters the stage coolers as shown in Fig. 10. Increase in axial thrust force on the thrust bearing to 59.838 kN which is equal to 110.9% of rated bearing load 53.955 kN, may damage the pads of bearing. Thrust force after washing of the compressor was decreased to 42.369 kN which is equal to 78.53 % of rated bearing load 53.955 kN as shown in Table 2.

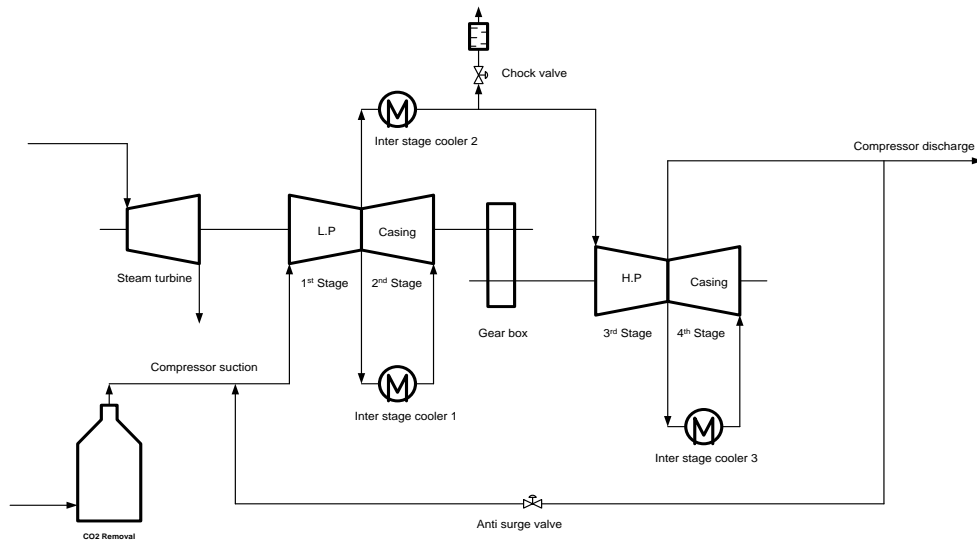
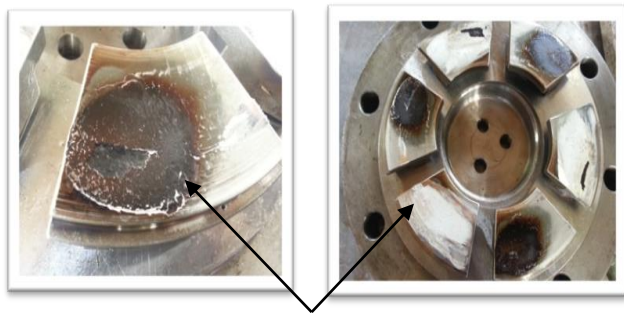
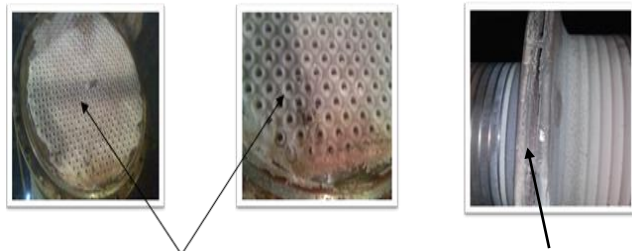

Fig. 8: CO2 Process diagram



Erosion

Fig. 9: Erosion in the thrust bearing



Fouling of inters stage coolers Fouling inside the impellers

Fig. 10: Fouling of inters stage coolers and impellers

TABLE 2

RESIDUAL THRUST LOAD AT DESIGN, HIGH LOAD AND COMPRESSOR WITH FOULING

	At design	At high load	Comp. with fouling	After comp. washing
Residual thrust load (N)	7.3821	31.547	59.838	42.369
From rated load (%)	13.68	58.47	110.9	78.53
Rated bearing load (kN)	53.955			

Fig. 11 explains the fouling effect on axial rotor thrust for the high pressure casing after complete overhaul (in years 2012-2013) for the compressor within 24 months of operation the compressor after overhaul. In existence of

fouling by 0.01 % an accumulation event for the fouling inside the impellers led to an increase in discharge pressure for the 3rd stage from 85.3 bar a until it reached highest value in this period to 96.1 bar a. This results in an increase axial thrust force in active side direction for thrust bearing from 27.265 kN which is equal to 50.53 % of rated bearing load until it reached highest value in this period to 59.838 kN which is equal to 110.9 % of rated bearing load. This was calculated at different operating days

The fouling effect on axial rotor thrust for the high pressure casing after complete overhaul (in years 2017-2018) is explained for the compressor within 12 months of operation the compressor after overhaul and in existence of fouling by 0.01 % an accumulation event for the fouling inside the impellers led to an increase in discharge pressure for the 3rd stage from 86.1 bar a until it reached highest value in this period to 91.5 bar a. This results in an increase axial thrust force in active side direction for thrust bearing from 28.01 kN which is equal to 51.91 % of rated bearing load until it reached highest value in this period to 41.779 kN which is equal to 77.43 % of rated bearing load. This was calculated at different operating days as shown in Fig. 12. Axial thrust force effect on thrust bearing during different loads for the compressor is shown in Fig. 13.

IV. AXIAL THRUST FORCE REDUCTION BY USING BALANCE DRUM

As mentioned before, the increase in axial force on high pressure rotor for carbon dioxide compressor in the 3rd stage suction direction become more than axial force in the 4th stage suction direction which led to an increase the axial force in the direction of thrust bearing active side It resulted thrust bearing failure more than once.

It was thought to work axial thrust balance for the rotor, from Fig. 14: A balance drum was installed on the 4th stage suction to generate a opposite force for axial force in the 3rd

stage suction direction.

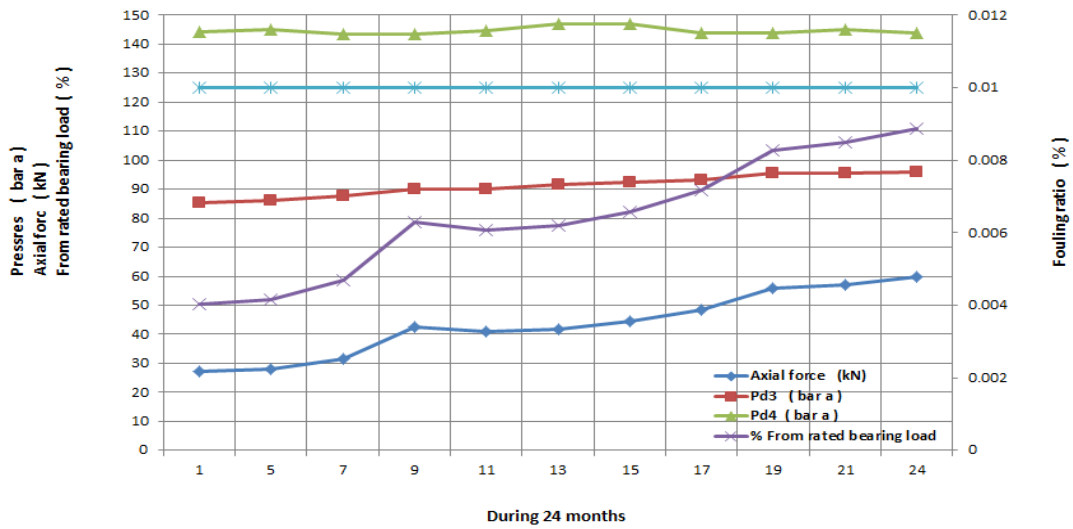

Fig. 11: Axial thrust force during 24 months after complete overhaul for the compressor

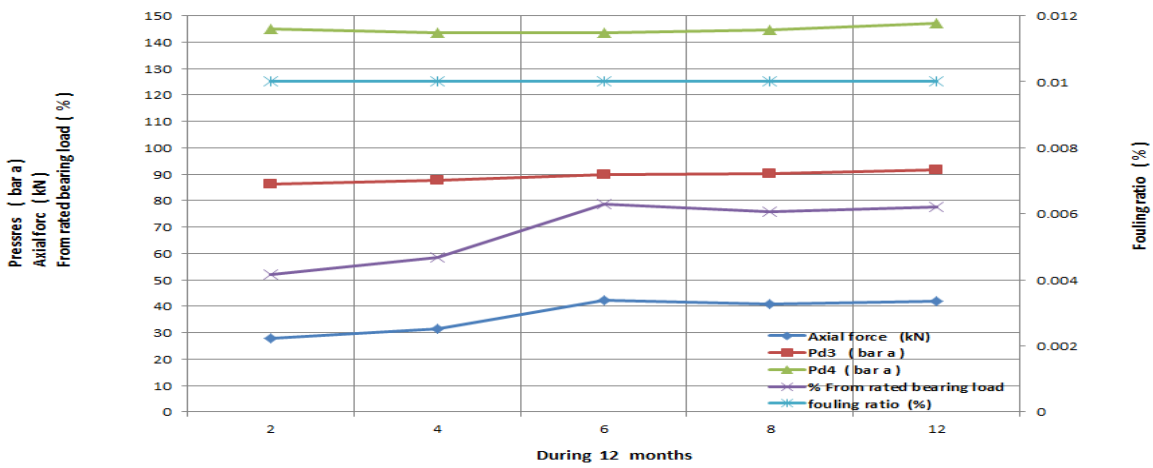

Fig. 12: Axial thrust force during 12 months after complete overhaul for the compressor



Axial thrust force 59.84 kN is equal 110.9 % from rated bearing load.

Axial thrust force 40.93 kN is equal 75.85 % from rated bearing load.

Axial thrust force 48.48 kN is equal 89.85 % from rated bearing load.

Fig. 13: Axial Thrust Force Effect on Thrust Bearing

The balance drum consists of a rotating element, which has a specified diameter, and extended rim for sealing the area adjacent to the balance drum is vented normally to suction of the 3rd stage by balancing line. The differential pressure across the balance drum acts on the balance drum area to develop a thrust force opposite that generated by the impellers.

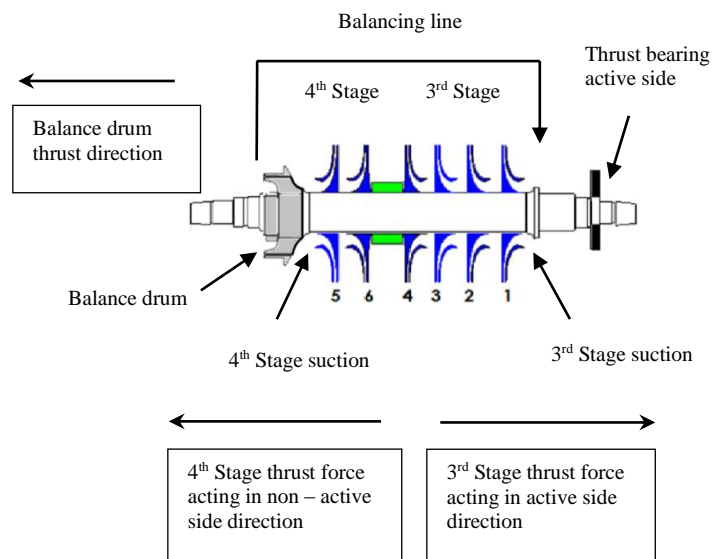

Fig. 14: Rotor with balance drum

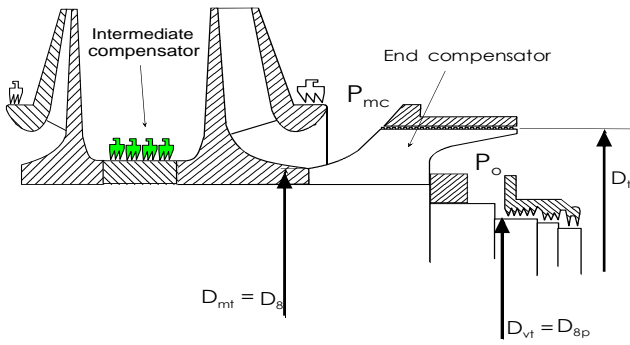

Fig. 15: Scheme for determination of balance drum

▪ *Determine the Diameter of the Balance Drum at Different Loads for the Compressor*

By using the equation no. (7), the diameter of balance drum (D_t) is calculated at different loads for the compressor as shown in table 3.

TABLE 3

DIAMETER OF BALANCE DRUM (D_t) AT DIFFERENT LOADS FOR THE COMPRESSOR

M/C	P_o (Bar abs)	P_{mc} (Bar abs)	D_{mt} (mm)	D_{vt} (mm)	Residual thrust force (kN)	D_t (mm)
At design operating condition	20.85	75.24	147	130	7.3821	158.668
At high load	26.5	86.7	147	130	31.547	174.595
Compressor with fouling	26	95.1	147	130	59.838	186.065

▪ *Axial Rotor Thrust Calculations by using Balance Drum ($D_t = 158.6686$ mm) at Different Loads for the Compressor*

From Fig. 16, when using the balance drum diameter $D_t=158.6686$ mm, the highest value of axial thrust force is equal to 50.282 kN (93.193 % of rated bearing load 53.955 kN) (at point 1). This is unacceptable because residual thrust in specified operating conditions is less than 50 % of thrust bearing maximum allowable load.

▪ *Axial Rotor Thrust Calculations by using Balance Drum ($D_t = 174.595$ mm) at Different Loads for the Compressor*

From Fig. 17, when using the balance drum diameter $D_t=174.595$ mm the highest value of axial thrust force is equal to -22.242 kN (41.22 % from rated bearing load 53.955 kN) (at point 1). And at the highest load of the compressor is equal to 0 kN (at point 2) by calculations. This is acceptable because residual thrust in specified operating conditions is less than 50 % of thrust bearing maximum allowable load.

▪ *Axial Rotor Thrust Calculations by using Balance Drum ($D_t = 186.065$ mm) at Different Loads for the Compressor*

From Fig. 18, when using the balance drum diameter $D_t=186.065$ mm the highest value of axial thrust force is equal -39.578 kN (73.35 % from rated bearing load 53.955 kN) (at point 1). This is unacceptable because residual thrust in specified operating conditions is less than 50 % of thrust bearing maximum allowable load.

▪ *Axial Rotor Thrust Calculations with and without Balance Drum*

Table 4 shows the diameter of balance drum $D_t=174.595$ mm that is chosen due to highest value for axial thrust force at this diameter to be equal - 22.242 kN (41.22 % of rated bearing load). While at the diameter $D_t = 158.6686$ mm highest value for axial thrust force is equal 50.282 kN (93.193 % of rated bearing load).

TABLE 4

AXIAL ROTOR THRUST CALCULATIONS WITH AND WITHOUT BALANCE DRUM

	Rotor without balance drum		Rotor with balance drum					
			$D_t= 158.66686$ mm		$D_t= 174.595$ mm		$D_t= 186.065$ mm	
	kN	%	kN	%	kN	%	kN	%
At design operating conditions	7.382	13.68	0	0	-22.242	41.22	-39.578	73.35
At high load without fouling	31.547	58.47	24.618	45.628	0	0	-19.188	35.56
Compressor with fouling	59.838	110.9	50.282	93.193	22.024	40.82	0	0
Rated bearing load	53.955 kN							

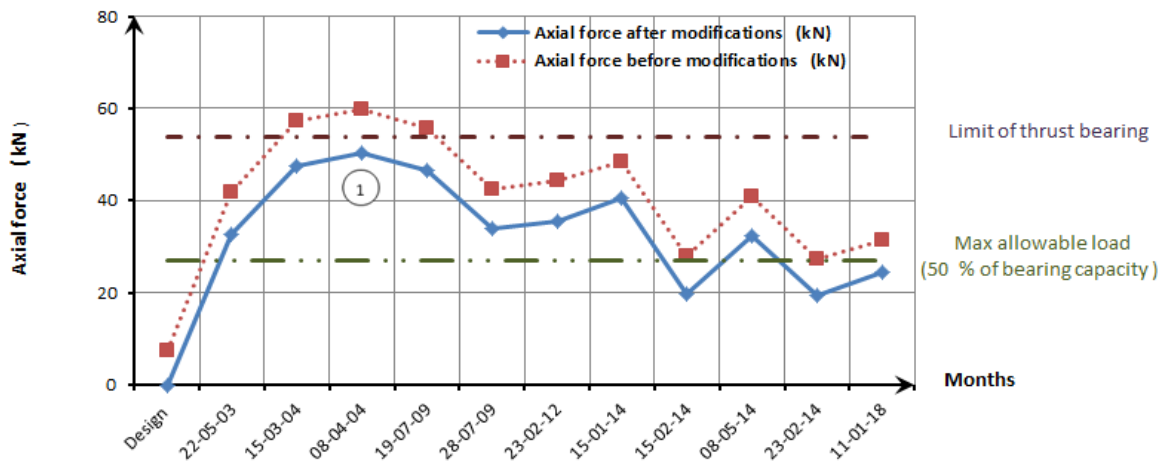

Fig. 16: Axial force with diameter of balance drum ($D_t = 158.6686$ mm)

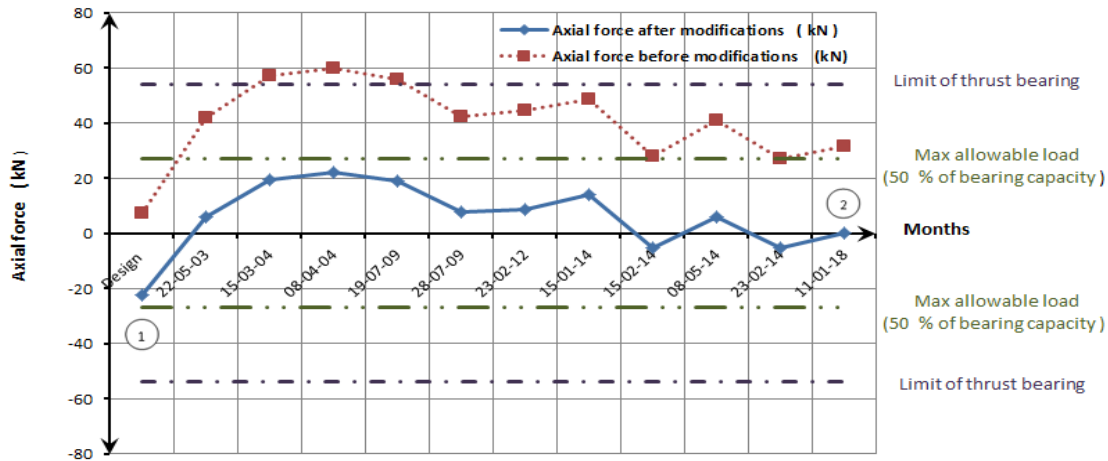

Fig.17 Axial force with diameter of balance drum ($D_t = 174.595$ mm)

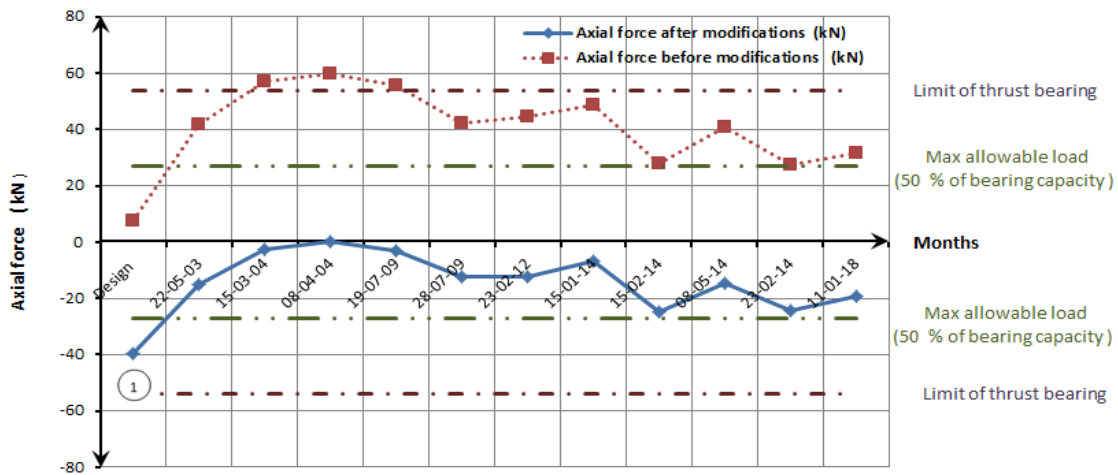

Fig. 18: Axial force with diameter of balance drum ($D_t = 186.065$ mm)

At diameter $D_t = 186.065$ mm highest value for axial thrust force is equal -39.578 kN (73.35 % of rated bearing load). The calculated axial thrust force with the selected balance drum with diameter 174.595 mm is given in Table 5 and Fig. 19.

TABLE 5

THE CALCULATED THRUST FORCE WITH THE SELECTED BALANCE DRUM DIAMETER 174.595 MM

	Rotor without balance drum		Rotor with balance drum $D_t= 174.595$ mm	
	kN	%	kN	%
At design operating conditions	7.382	13.68	-22.242	41.22
At high load without fouling	31.547	58.47	0	0
Compressor with fouling	59.838	110.9	22.024	40.82
Rated bearing load	53.955 kN			

V. CONCLUSIONS

The axial thrust calculations at different operating conditions for the carbon dioxide compressor are summarized as follows:

- Residual thrust load for high pressure rotor for the compressor before modification at design operating condition is equal 13.68 % of rated bearing load, while at the high load without fouling effect for the compressor is equal 58.4 % from rated bearing load and compressor with fouling effect is equal to 110.9 % of rated bearing load.
- Residual thrust load for high pressure rotor for the compressor, when using the balance drum diameter $D_t=158.6686$ mm, the highest value of axial thrust force is equal to 93.193 % of rated bearing load. This is unacceptable because residual thrust in specified operating conditions must be less than 50 % of thrust bearing maximum allowable load.
- Residual thrust load for high pressure rotor for the compressor, when using the balance drum diameter $D_t=174.595$ mm, the highest value of axial thrust force is equal to 41.22 % of rated bearing load at design operating conditions, while at the highest load of the compressor without fouling effect is equal to 0

% of rated bearing load. Considering the fouling effect the axial thrust force is equal to 40.82 % of rated bearing load. This is acceptable because residual thrust in specified operating conditions is less than 50 % of thrust bearing maximum allowable load.

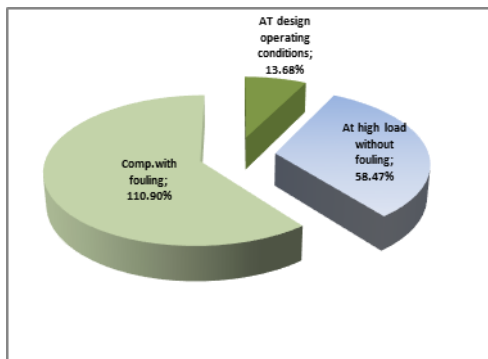

(a) Axial force [% from rated bearing load] without balance drum

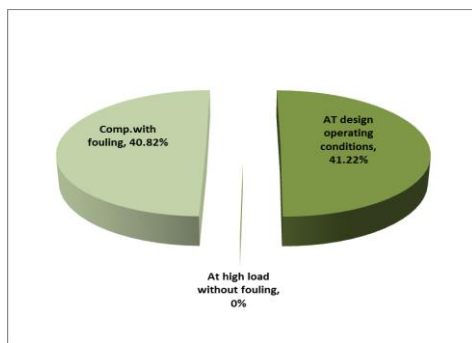

(b) Axial force [% from rated bearing load] with balance drum

Fig. 19: Axial force [% from rated bearing] with and without balance drum

- Residual thrust load for high pressure rotor for the compressor, when used the balance drum diameter $D_t=186.065$ mm, the highest value of axial thrust force is equal to 73.35 % of rated bearing load. This is unacceptable because residual thrust in specified operating conditions must be less than 50 % of thrust bearing maximum allowable load.

Nomenclature

M	Molecular weight, kg/mole.
R	Gas constant.
P_1	Impeller inlet pressure , bar a.
P_2	Impeller outlet pressure , bar a.
P_s	Stage suction pressure , bar a.
P_d	Stage discharge pressure , bar a.
T	Temperature , K
N	Polytropic index.
Z_m	Mean compressibility factor.
P_{cr}	Critical pressure , bar a.
T_{cr}	Critical temperature , K.
H_p	Polytropic heat, kJ/kg.
Q_{act}	Actual flow rate , m ³ /h.
m	Mass flow rate , kg/s.
A_{av}	Average area of phase, m ² .
A	Impeller inlet area, m ² .

ρ	Gas density, kg/m ³ .
F_m	Momentum thrust , N.
F_i	Inlet thrust , N.
F_s	Shroud thrust , N.
F_H	Hub thrust , N.
F_{SE}	Secondary effect , N.
$F_{Comp.}$	Compensator thrust , N.
K	Surface factor.
n^*	No. of impellers.
D_t	Diameter of balance drum, mm.
D_{vt}	Seal diameter downstream balance drum, mm.
	Seal diameter upstream balance drum, m.
D_{mt}	Static reference pressure for balance drum, bar a.
P_o	Static reference pressure upstream balance drum, bar a.
P_{mc}	Degree of reaction.

R E

References

- [1] API Standard 617 (1995) centrifugal compressors for petroleum, chemical, and gas service industries.6th edn, American petroleum institute, Washington, D.C.
- [2] Zimmermann H, Radtke F, Ziemann M (1983) Scheibenreibung - Experimentelle und theoretische Untersuchungen des Reibungseinflusses an rotierenden Scheiben, FVV Forschungsberichte, Forschungsvereinigung Verbrennungskraftmaschinen, Frankfurt, Germany, Heft 331; restricted (in German).
- [3] Lempart A (1992) Das Axialschubverhalten von industriellen Turboverdichtem. VDI Berichte 947 pp 177-194; Conference Turbocompressors in Industrial Use, 1992, Hannover, Germany; Verein Deutscher Ingenieure, VDI-Verlag, DÜsseldorf, Germany (in German).
- [4] Yves Bidaut , Dominique Dessibourg , “ The challenge for the accurate determination of the axial rotor thrust in centrifugal compressors ”, 43rd Turbomachinery & 30th Pump Users Symposia , September 2014.
- [5] Vasant Godbole , Rajashri Patil , S.S.Gavade, “ Axial thrust in centrifugal pumps – experimental analysis ”, 15th International Conference on Experimental Mechanics , July 2012.
- [6] K J Zanker, “Experiments with back vanes used for balancing axial thrust on centrifugal pump impellers”, British Hydromechanics Research Association, Vol. 3, 5th Annual meet. (Apr. 1962), pp.7-14. 2
- [7] A.J. Stepanoff, “Centrifugal and Axial flow pumps - Theory, Design & Application”, John Wiley and Sons – 2nd edition – 1953. pp. 182-223
- [8] Val S. Lobanoff & Robert R. Ross, “Centrifugal Pumps design and application”, Jaico publishing house – 2nd edition 1995. pp. 333-353.
- [9] Royce N.Brown , “ Compressors selection and sizing”, Jun 2005.
- [10] Dominique Dssibourg,Yves Bidout “the challenge for the accurate determination of the axial rotor thrust in centrifugal compressor”,2014.
- [11] Lihao Zhangling Hu,Lidong He and Haoran Feng “Honeycomb seal technology achieves superior sealing effect in centrifugal air compressor”, June 2018.
- [12] Denis Guillaume Jean “Balance drum configuration for compressors”, Nov.17, 2011.
- [13] Ivan Pavlenko “Investigation of nonlinear axial rotor oscillations of the multistage centrifugal compressor with the automatic balancing device”, November 2013.
- [16] Urs Boumann , Yves Bidout “Rotor dynamic stability of A9500 psireinjection centrifugal compressor equipped with a hole pattern seal – measurement versus prediction taking into account the operational boundary conditions ”,2009.
- [17] M.Alyahyai,D.Mba“Rotor dynamic response of centrifugal compressor due to liquid carry over”,2014.
- [18] Vasant Godbole , Rajashri Patil,S.S Gavade“Axial thrust in centrifugal pumps – Experimental analysis”,July 2012.
- [19] Abdulkareem Abdulwahab Ibrahim“Balancing axial thrust in the single – suction one stage centrifugal pump by hydraulic balance holes”,2016.
- [20] Andrzej wilk “laboratory investigations and theoretical analysis of axial thrust problem in high rotational speed pumps”,January 2009.