

Possibility of Generating Heat Energy from Some Agricultural Residues

Amin, E. A. ; H. El. Abd Alla and H. A. AL-Fartosi

Agricultural Engineering Dept., Faculty of Agriculture, Mansoura University.



ABSTRACT

The present research aims to study the possibility of generating heat energy from four common Egyptian, agricultural wastes (rice straw, corn stovers, cotton stalks, and sawdust) through thermal decomposition technology in order to select the best residues that can be used as feedstock for the pyrolysis reactors. The generating of heat energy from the four deduced agricultural wastes was experimentally investigated in a pyrolysis reactor designed in the workshop of the Agricultural Engineering Department faculty of Agricultural Mansoura University. Meanwhile, a series of experiments have been performed to explore the effects of biomass particle size and the provided air quantity on gas composition and gas yields of the thermochemical decomposition of the four deduced agricultural wastes. The influences of biomass particle sizes and the provided air quantities on the compounds existing in exhaust gasses obtained from the four tested agricultural wastes samples were examined in relation to the yield and composition of the gasses product. The gasses products were measured and analyzed by a gas analyzer. Whereas, the emission rates of CH₄, CO₂, and O₂ produced from each waste samples were described by means of exhaust gasses percentages. The obtained results indicated in general that the CH₄ percentages emitted from the four tested residues were highly dependent on residue lengths and provided amount of fresh air. Whereas, the highest CH₄ percentages were 72.6, 77.5, 79.2 and 76.2%) for the thermal decomposition pressing of rice straw, corn stovers, cotton stalks, and sawdust respectively. These maximum CH₄ percentages were accomplished residue lengths of 15 cm and zero provided amount of fresh air. The CO₂ maximum percentages were 28.1, 25.2, 25.0 and 25.3 % respectively. These percentages were accomplished residue lengths of 20 cm and 0.006 m³/min provided amount of fresh air. The corresponding O₂ maximum percentages were 0.56, 0.53, 0.51 and 0.5.

INTRODUCTION

Indiscriminate and inefficient burning of agricultural residues being presently practiced in the most countries has resulted in environmental pollution and health hazards. In recent years, there is a great concern with the environmental problems associated with the great CO₂, NO_x and SO_x emissions resulting from the rising use of fossil fuels. There is strong interest in the farming community to increase energy self-reliance and identify non-food uses for agricultural crops (Jannasch *et al.*, 2001). For this reason, more attention is being paid to renewable energy especially biomass energy. Biomass feedstock including wood, industrial and agricultural residue and by products or dedicated energy crops usually applied as biomass fuels are significant interest because biomass is the fourth largest source of energy in the world, accounting for about 15% of the world's primary energy consumption and about 38% of the primary energy consumption in developing countries (Chen *et al.*, 2003). Therefore, there is the need to generate alternative forms of energy in order to shift attention from fossil fuels, which are expensive and environmentally unfriendly. In Egypt, large quantities of agricultural residues are produced annually (GIZ, 2014 and Ministry of Agriculture and Land Reclamation in Egypt, 2015), However it is unfortunate that these residues are badly managed. In most cases, these residues are burned in the field or they are left to rot away. Most of these residues contain enormous amounts of energy. In addition, statistics point out that agricultural waste reaches 30 million tons on the national level (Shaban and Sawan, 2010). This results in poor waste disposal, which in itself contributes to environmental pollution and constitutes a public nuisance and eye-sore. However, these residues, if properly harnessed and managed, will go a long way to alleviate some of the energy crisis being experienced in the country. Hassan *et al.*, (2014) The volume of the

agricultural wastes is estimated in Egypt by about 35 million tons per year, of which about 23 million tons of vegetarian wastes (utilized by about 7 million tons feed, 4 million tons of organic fertilizer and about 12 million tons are left without avail), in addition to animal wastes which reach to about 12 million tons per year (utilized by about 3 million tons as organic fertilizer and about 9 million tons, per year, are left without avail). This refers to that about 21 million tons of agricultural wastes, per year, (plant and animal) are left without avail. These wastes lead to the pollution of the agricultural environment, in addition to health damage for citizens and lead to economic loss of about 4.6 billion pounds a year as an average for the period (2004-2012) furthermore, this can be considered as a waste for the natural resources from which benefits can be maximized. GIZ (2014) reported that, The "Annual Report for Solid Waste Management, in Egypt, 2013" studies factors contributing to the systems failure and recommendations for future perspectives as commissioned by GIZ and the newly established national solid waste management program. Egypt produced 89.03 million tons of solid waste, including 30 million tons of agricultural waste. Sharma *et al.*, (2010) Reported that burning of crop residues not only degrade the atmospheric quality but also affect the climate and ultimate the human health. Crop residue and biomass burning are considered as a major source of carbon dioxide (CO₂), carbon monoxide (CO), methane (CH₄), volatile organic compounds (VOC), nitrogen oxides and halogen compounds. Biomass burning is a major source of gaseous pollution such as carbon monoxide (CO), methane (CH₄), nitrous oxides (NO_x) and hydrocarbons in the troposphere (Crutzen and Andreae, 1990). It is also a significant source of aerosol in the atmosphere, having potential impact on global air quality and chemistry of climate (Yang *et al.*, 2008). Open agricultural crop residues, burning release a great amount of pollutants to the atmosphere, which includes

aerosols and hydrocarbons (Duan *et al.*, 2004). The gasification process produces gaseous products mainly consisting of methane (CH₄), hydrogen (H₂), carbon monoxide (CO) and carbon dioxide (CO₂). These products can be used for power and heat generation or for gaseous and hydrocarbon liquid fuel production in a Fischer-Tropsch process (Klass, 1998). Biomass energy is the one the earliest and now the third largest global source of energy, comprising up to 40%–50% of energy usage in many developing countries that have large agriculture and forest areas (Vamvuka *et al.*, 2003). Pyrolysis is defined as the thermal chemical decomposition of organic materials in the absence of oxygen, or partially combusted in a limited oxygen supply, to produce a hydrocarbon rich gas mixture, an oil-like liquid and a carbon rich solid residue (Demirbas, 2000).

The aim of this work was to investigate the energy potentials of four agricultural residues commonly found in Egypt and to characterize Pyrolysis

conversion of these residues with a view to determining which of them give optimal yields.

MATERIALS AND METHODS

Materials:

Four different Agricultural residues types were used in the present study namely:- these materials are, rice straw, corn stover, cotton stalks and sawdust as shown in fig (1).

A sample of 5kg weight from fine sawdust was collected from the carpentry workshop of Agricultural Engineering Department Faculty of Agricultural Mansoura University Egypt.

There other three field sample each 8kg of (rice straw, corn stover and cotton stalks) were gathered from Meet Kamees Village, Mansoura Governorate, Egypt. Each 8kg sample field residues kind was divided into (4) subsamples according to the its chopped length (5, 10, 15 and 20 cm).



Fig. (1): Agricultural residues (A. Rice straw, B. Corn stover, C. Cotton stalks and D. Sawdust).

According to the tested material specifications 0.5kg from each subsample after cutting process was took to determine moisture content and balk density of each investigated farm residues type.

1-Moisture content determination :

The moisture content was determined by using oven method at 105°C for 72 hours (Matouk., *et al* 1981), Average moisture content of (Rice straw, Corn stover, Cotton stalks and Sawdust) were (11, 15, 12 and 13%) respectively.

2-Balk density (B.D) was determined by weight known volume (V) from each sample and divide the weight (w) on the volume

$$B.D \text{ g/cm}^3 = \frac{W (g)}{V (\text{cm}^3)}$$

Average balk density of (Rice straw, Corn stover, Cotton stalks and Sawdust) were (0.09, 0.08, 0.13 and 0.12 dry basis g/cm³) respectively.

The Pyrolysis reactor:

To burn field residues in the absence of oxygen and study the properties and calorific values of each sorted of Pyrolysis products gasses for all field residues under study a small experimented apparatus (prototype) was designed and manufactured in Faculty of Agriculture Mansoura University Egypt as shown in Fig(2).

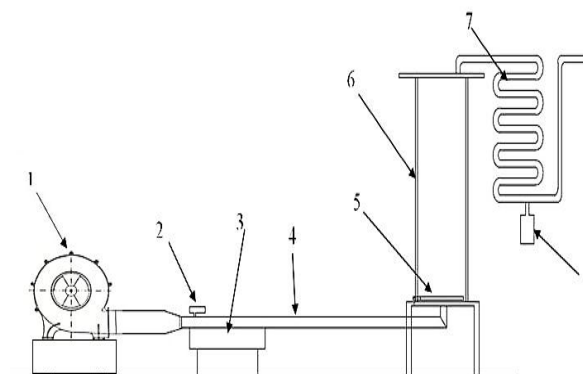

Fig. (2): Main components of the used pyrolysis reactor

- 1- The electric blower
- 2- Valve
- 3- Cursor
- 4- Air transporting pipe (110cm length and 1.28cm diameter)
- 5- Electric heater hand shape (220v-1500w)
- 6- The burning cylinder (55cm height and 22cm inside diameter)
- 7- The twisted tube (serpentine) length 295cm and 1cm diameter
- 8- The Stockiest tar (10cm length and 7cm diameter)

Studied factors:

The experimental factors the deduced in experiments, were as follows:

- 1-Four types of agricultural residues namely (sawdust, rice straw, corn stover and cotton stalks).

- 2- Three levels of residues lengths were tested in the experiments there lengths were (5, 10, 15 and 20cm) for each of (rice straw, corn stover and cotton stalks).
- 3- Provided air quantity: the burner was provided with small quantities of atmospheric air to contribute continuity the pyrolysis operation. There are four rates (zero, 0.002, 0.004 and 0.006m³/min) of air were pumped in the burning cylinder.

Experimental procedures:

- Preparing the samples and subsamples of biomass feed stock from the four tested agricultural residues types.
- Interring in sequences each subsample one subsample in the burning cylinder and covered it.
- Providing the desired amount of fresh air through controlling air valve.
- Transmit the electric power (220v) to the electric heater.
- Cutting of the electric power after the burning of field residues in the absent of oxygen in order to permit all residues amount to be burned.
- Gathering the produced gasses for each investigated treatments in special plastic sacs using suction tubes.

Experimented measurements:

Many measurements related to the percentage of the produced gases (CH₄, CO₂ and O₂) for the fifty two (52) treatment. To carry out these measurements the produced mix gasses was shifted from the reactor in a plastic sacs consequently, the collected gas samples were analyses to determine the percentages of CH₄, CO₂ and O₂ gasses. For the gas analyses, a gasses analyses (GA 500) was used to corpse purpose the crossed analysis process agricultural research center (A. R. C) was carried out in Alexandria governorate.

RESULTS AND DISCUSSION

The present work is focusing on the possibility of generating heat energy from four different agriculture residues through the pyrolysis process. The obtained results may be drawn and discussed under the following headlines:

The emission rates of CH₄, CO₂ and O₂ produces from rice straw biomass:

The obtained data related to the percentage of CH₄ produced from rice straw as affected by the studied variables are shown in fig (3) that the CH₄ percentage in rice straw exhaust gasses was highly dependent on the length of rice straw and amount of provided fresh air. Where, the highest CH₄ percentage in rice straw exhaust gasses (72.6 %) was resulted from 15 cm length of rice straw exhaust gasses and zero amount of fresh air. While, the lowest value of CH₄ percentage in rice straw exhaust gasses (66.6 %) was resulted from most lengths of rice straw exhaust gasses (5, 10 and 20 cm) and highest amount of fresh air (0.006 m³/min).

To determine the interaction effects of both rice straw length and amount of provided fresh air on CH₄ percentage in rice straw exhaust gasses, a multiple regression analysis was employed and equation (1) was derived:

$$CH_4 \% = 72.0075 + 0.009 L - 927.5 A \quad (R^2 = 0.98) \dots (1)$$

This results trend may be due to, within high quality of fresh air in trend in burner the oxygen in fresh air interact with the active carbon producing CO and CO₂ that reduce the chance for carbon to pound with H₂ to produce CH₄.

This result trend is identical with (Radlein, 1999), which state that, the H₂ produced during burned the biomass in the absence of oxygen is reacted with carbon and generates CH₄ and CO.

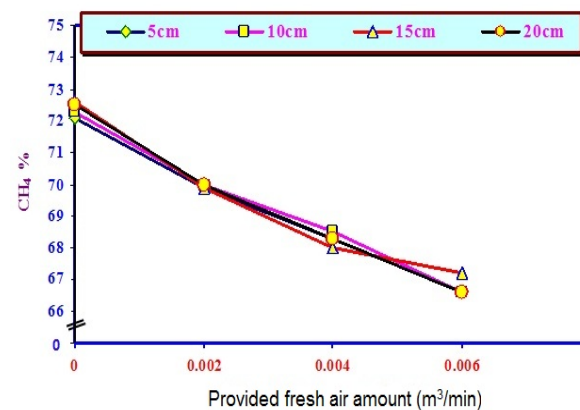

Fig. (3): CH₄ percentage as affected by rice straw lengths and provided air amount.

The obtained data related to the percentage of CO₂ produced from rice straw as affected by the studied variables are shown in fig (4). The lowest CO₂ percentage in rice straw exhaust gasses (21.9 %) was resulted from 15 cm length of rice straw exhaust gasses and zero amount of fresh air. While, the highest CO₂ percentage in rice straw exhaust gasses (28.1 %) was resulted from 20 cm length of rice straw exhaust gasses and highest amount of fresh air (0.006 m³/min).

To determine the interaction effects of both rice straw length and amount of provided fresh air on CO₂ percentage in rice straw exhaust gasses, a multiple regression analysis was employed and equation (2) was derived:

$$CO_2 \% = 22.79 + 0.027 L + 532.5 A \quad (R^2 = 0.457) \dots (2)$$

This trend (direct relationship) is logic due to where presented more oxygen this encourage it oxidation process of active carbon and converting to carbon dioxide.

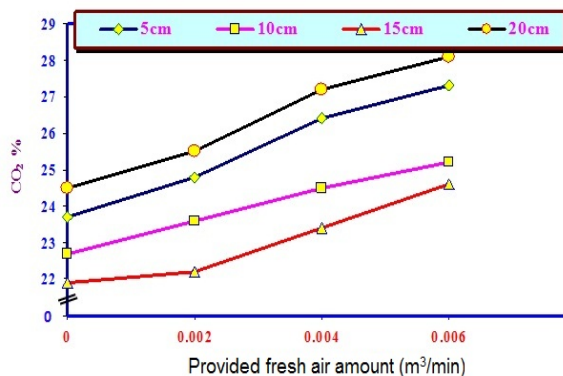

Fig. (4): CO₂ percentage as affected by rice straw lengths and provided air amount.

The obtained data related to the percentage of O₂ produced from rice straw as affected by the studied variables are shown in fig (5). The O₂ percentage in rice straw exhaust gasses was highly dependent on length of rice straw exhaust gasses and amount of fresh air. Where, the highest value of O₂ percentage in rice straw (0.56 %) was resulted from 20 cm length of rice straw exhaust gasses and highest amount of fresh air (0.006 m³/min). On the contrast, the lowest value of O₂ percentage in rice straw exhaust gasses (0.13 %) was resulted from 5 cm length of rice straw and zero amount of fresh air.

To determine the interaction effects of both rice straw length and amount of provided fresh air on O₂ percentage in rice straw exhaust gasses, a multiple regression analysis was employed and equation (3) was derived:

$$O_2 \% = 0.104 + 0.0106 L + 40.75 A \quad (R^2 = 0.976) \dots\dots (3)$$

These results may be ascribed to biomass combustion starts by heating and drying the feedstock. After all of the moisture has been removed, temperature rises for pyrolysis to occur in the absence of oxygen. The major products are hydrogen, CO, CO₂, CH₄ and other hydrocarbons. In the end, char and volatile gases are formed and they continue to react independently. The volatile gases need oxygen in order to achieve complete flame combustion. Mostly CO₂ and H₂O result from complete combustion. The solid char burns as well, resulting CO and CO₂ (Jameel *et al.*, 2010 and Roos, 2010).

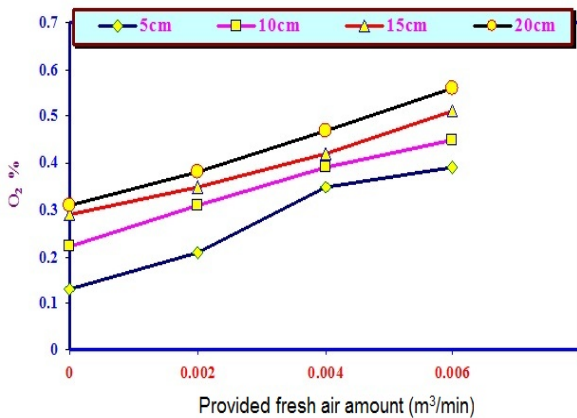

Fig. (5): O₂ percentage as affected by rice straw lengths and provided air amount.

The emission rates of CH₄, CO₂ and O₂ produces from corn stover biomass:

The obtained data related to the percentage of CH₄ produced from corn stover as affected by the studied variables are shown in fig (6). Each increase in amount of fresh air was correlated with obvious decrease in CH₄ percentage in all length of corn stover. The highest CH₄ percentage in corn stover (77.5 %) was resulted from 15 cm length of corn stover and zero amount of fresh air. While, the lowest CH₄ percentage in corn stover (69.5 %) was resulted from 5 cm length of corn stover and highest amount of fresh air (0.006 m³/min).

To determine the interaction effects of both rice straw length and amount of provided fresh air on CH₄ percentage in corn stover exhaust gasses, a multiple regression analysis was employed and equation (4) was derived:

$$CH_4 \% = 74.71875 + 0.0805 L - 793.75 A \quad (R^2 = 0.7557) \dots\dots (4)$$

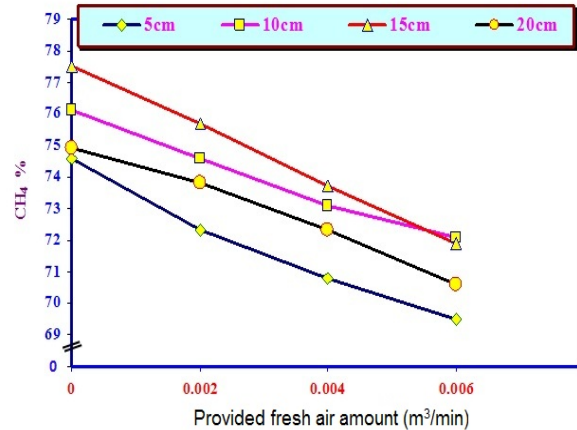

Fig. (6): CH₄ percentage as affected by corn stover lengths and provided air amount.

The obtained data related to the percentage of CO₂ produced from corn stover as affected by the studied variables are shown in fig (7). The CO₂ percentage in corn stover was highly dependent on length of corn stover and amount of fresh air. Where, the lowest CO₂ percentage in corn stover (18.4 %) was resulted from 15 cm length of corn stover exhaust gasses and zero amount of fresh air. While, the highest CO₂ percentage in corn stover exhaust gasses (25.2 %) was resulted from 5 cm length of corn stover and highest amount of fresh air (0.006 m³/min).

To determine the interaction effects of both rice straw length and amount of provided fresh air on CO₂ percentage in corn stover exhaust gasses, a multiple regression analysis was employed and equation (5) was derived:

$$CO_2 \% = 22.08875 - 0.1465 L + 591.25 A \quad (R^2 = 0.576) \dots\dots (5)$$

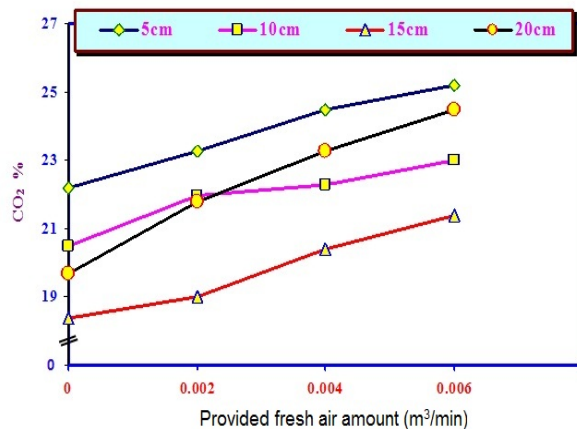

Fig. (7): CO₂ percentage as affected by corn stover lengths and provided air amount.

The obtained data related to the percentage of O₂ produced from corn stover as affected by the studied

variables are shown in fig (8). The highest value of O₂ percentage in corn stover exhaust gasses (0.53 %) was resulted from 20 cm length of corn stover exhaust gasses and highest amount of fresh air (0.006 m³/min). On the contrary, the lowest O₂ percentage in corn stover exhaust gasses (0.06 %) was resulted from 5 cm length of corn stover exhaust gasses and zero amount of fresh air.

To determine the interaction effects of both rice straw length and amount of provided fresh air on O₂ percentage in corn stover exhaust gasses, a multiple regression analysis was employed and equation (6) was derived:

$$O_2 \% = -0.008 + 0.0124 L + 48.5 A \quad (R^2 = 0.974) \dots\dots (6)$$

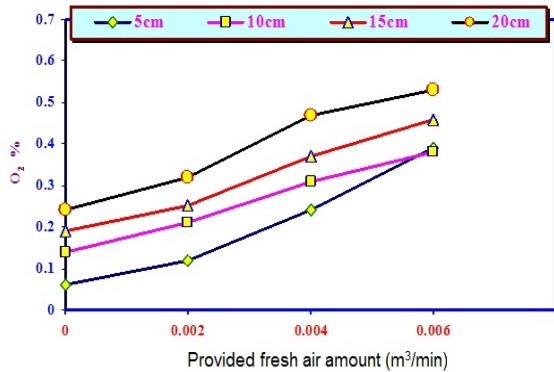

Fig. (8): O₂ percentage as affected by corn stover lengths and provided air amount.

The emission rates of CH₄, CO₂ and O₂ produces from cotton stalks biomass:

The obtained data related to the percentage of CH₄ produced from cotton stalks as affected by the studied variables are shown in fig (9). The highest value of CH₄ percentage in cotton stalks exhaust gasses (79.2 %) was resulted from 15 cm length of cotton stalks exhaust gasses and zero amount of fresh air. While, the lowest CH₄ percentage in cotton stalks exhaust gasses (68.8 %) was resulted from 20 cm length of cotton stalks exhaust gasses and highest amount of fresh air (0.006 m³/min).

To determine the interaction effects of both rice straw length and amount of provided fresh air on CH₄ percentage in cotton stalks exhaust gasses, a multiple regression analysis was employed and equation (7) was derived:

$$CH_4 \% = 79.53 - 0.19 L - 885 A \quad (R^2 = 0.611) \dots\dots (7)$$

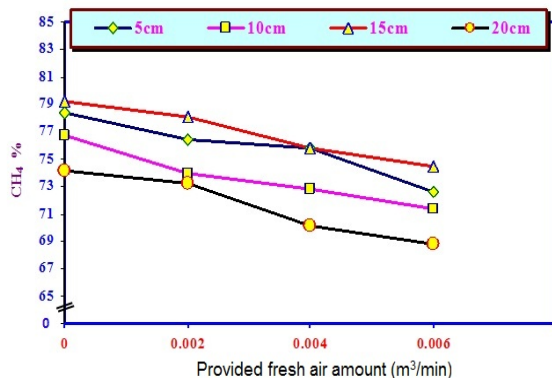

Fig. (9): CH₄ percentage as affected by cotton stalks lengths and provided air amount.

The obtained data related to the percentage of CO₂ produced from cotton stalks as affected by the studied variables are shown in fig (10). The CO₂ percentage in cotton stalks exhaust gasses was highly dependent on length of cotton stalks exhaust gasses and amount of fresh air. Where, the lowest CO₂ percentage in cotton stalks exhaust gasses (17.2 %) was resulted from 15 cm length of cotton stalks exhaust gasses and zero amount of fresh air. While, the highest value of CO₂ percentage in cotton stalks (25.0 %) was resulted from 20 cm length of cotton stalks exhaust gasses and highest amount of fresh air (0.006 m³/min).

To determine the interaction effects of both rice straw length and amount of provided fresh air on CO₂ percentage in cotton stalks exhaust gasses, a multiple regression analysis was employed and equation (8) was derived:

$$CO_2 \% = 16.38875 + 0.2125 L + 541.25 A \quad (R^2 = 0.559) \dots\dots (8)$$

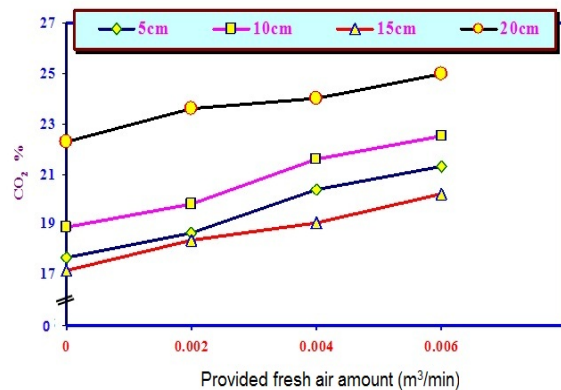

Fig. (10): CO₂ percentage as affected by cotton stalks lengths and provided air amount.

The obtained data related to the percentage of O₂ produced from cotton stalks as affected by the studied variables are shown in fig (11). The highest value of O₂ percentage in cotton stalks exhaust gasses (0.51 %) was resulted from 20 cm length of cotton stalks exhaust gasses and highest amount of fresh air (0.006 m³/min). On the contrary, the lowest O₂ percentage in cotton stalks exhaust gasses (0.07%) was resulted from 5 cm length of cotton stalks exhaust gasses and zero amount of fresh air.

To determine the interaction effects of both rice straw length and amount of provided fresh air on O₂ percentage in cotton stalks exhaust gasses, a multiple regression analysis was employed and equation (9) was derived:

$$O_2 \% = -0.03 + 0.0148 L + 38.75 A \quad (R^2 = 0.957) \dots\dots (9)$$

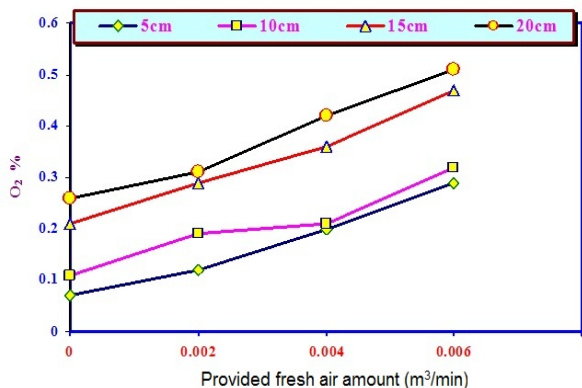

Fig. (11): O₂ percentage as affected by cotton stalks lengths and provided air amount.

The emission rates of CH₄, CO₂ and O₂ produces from sawdust biomass:

The obtained data related to the percentage of CH₄ produced from sawdust as affected by the studied variables are shown in fig (13).The increasing in amount of fresh air (m³/min) from 0 to 0.002, 0.004 and 0.006 m³/min tend to decrease in CH₄ percentage in sawdust exhaust gasses. The minimum CH₄ percentage in sawdust exhaust gasses was obtained from highest amount of fresh air 0.006 m³/min. On the other hand, the highest CH₄ percentage in sawdust exhaust gasses was from amount of fresh air (0.0 m³/min).

The obtained data related to the percentage of CO₂ produced from sawdust as affected by the studied variables are shown in fig (12).The highest CO₂ percentage in sawdust exhaust gasses (26.3 %) was resulted from highest amount of fresh air (0.006 m³/min). On the contrary, the lowest value of CO₂ percentage in sawdust exhaust gasses (17.6 %) was produced from zero amount of fresh air.

The obtained data related to the percentage of O₂ produced from sawdust as affected by the studied variables are shown in fig (14). Each increase in amount of fresh air (m³/min) from 0 to 0.002, 0.004 and 0.006 m³/min resulted in obvious increase in O₂ percentage in sawdust exhaust gasses. Where, the minimum O₂ percentage in sawdust exhaust gasses (0.2%) was obtained from zero amount of fresh air. Whereas, the highest O₂ percentage in sawdust exhaust gasses (0.5%) was obtained from highest amount of fresh air (0.006 m³/min).

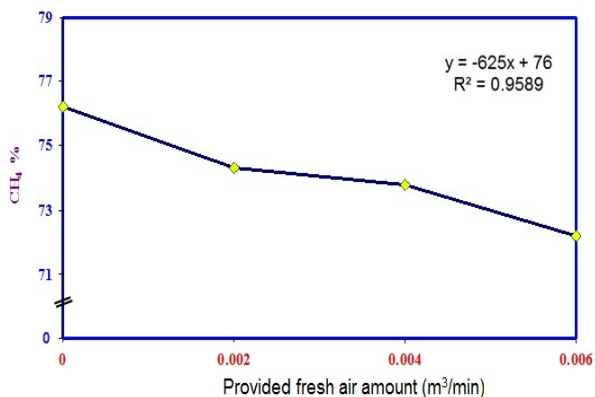

Fig. (12): CH₄ percentage as affected sawdust by provided air amount.

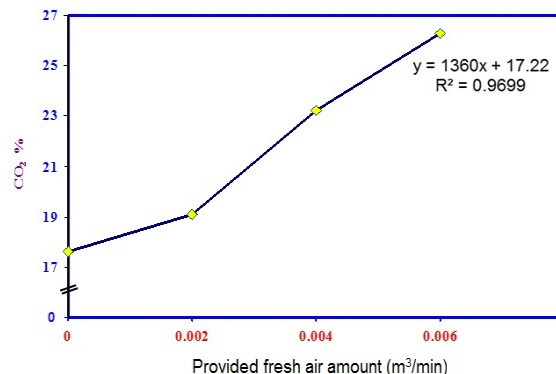

Fig. (13): CO₂ percentage as affected sawdust by provided air amount.

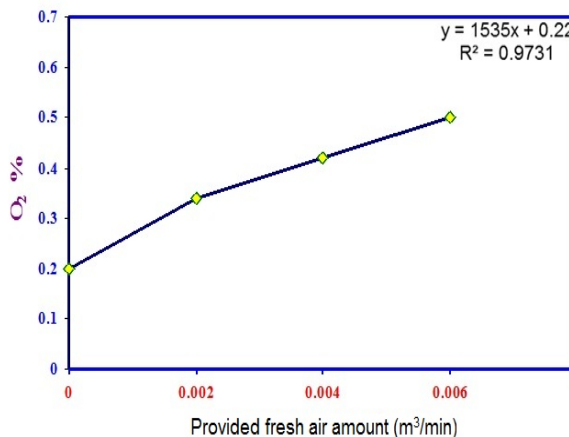

Fig. (14): O₂ percentage as affected sawdust by provided air amount.

The emission rates of CH₄, CO₂ and O₂ produces from all residues biomass:

Concerning effect of 5 cm length of all residues, the highest CH₄ percentage was resulted from cotton stalks, followed sawdust then corn stover at all amounts of fresh air. Whilst, the lowest CH₄ percentage was produced from rice straw at all amounts of fresh air as shown Fig. (15).

These results could be explained by the considerably high cellulose and hemicellulose contents in cotton stalks and sawdust. The results of gas evolution from cellulose and lignin pyrolysis carried out under otherwise similar conditions, confirm that cellulose decomposition produces significantly higher gas yield compared to lignin. These gas yield trends are in good agreement with other studies of pyrolysis experiments for different types of biomass (Graboski, 1981 and Worasuwannarak et al., 2007).

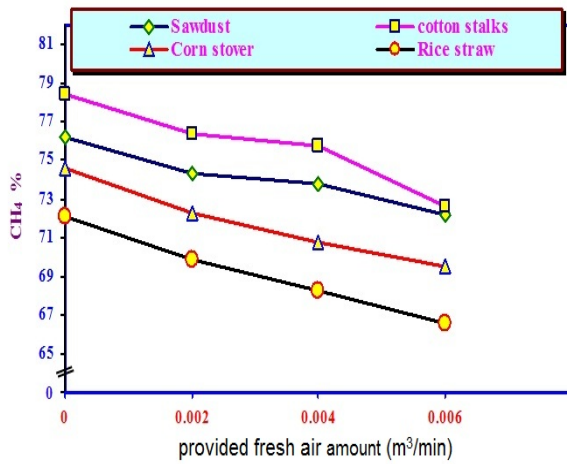

Fig. (15): CH₄ percentage as affected by residues type and provided air (m³/min) using small portion size.

The highest CO₂ percentage was produced from rice straw, followed corn stover then sawdust at all amounts of fresh air. At the same time as, the lowest CO₂ percentage was obtained from cotton stalks at all amounts of fresh air as shown Fig. (16).

These results may be due to the CO₂ evolution was formed during the primary decomposition of hemicellulose and cellulose with a smaller proportion of CO coming from lignin by the cracking of carbonyl (C-O-C) and carboxyl (C=O) in biomass (Yang *et al.*, 2007). In addition, the OH radicals released from biomass during payrolysis, react with aliphatic structures to form CO, which decreases the yields of gaseous hydrocarbons (Yuan *et al.*, 2012).

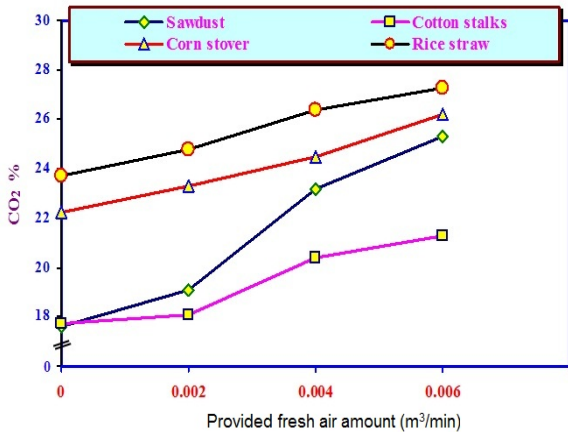

Fig. (16): CO₂ percentage as affected by residues type and provided air (m³/min) using small portion size.

The highest O₂ percentage was resulted from rice straw, followed sawdust then cotton stalks at all amounts of fresh air. Whilst, the lowest O₂ percentage was produced from corn stover at all amounts of fresh air as shown Fig. (17).

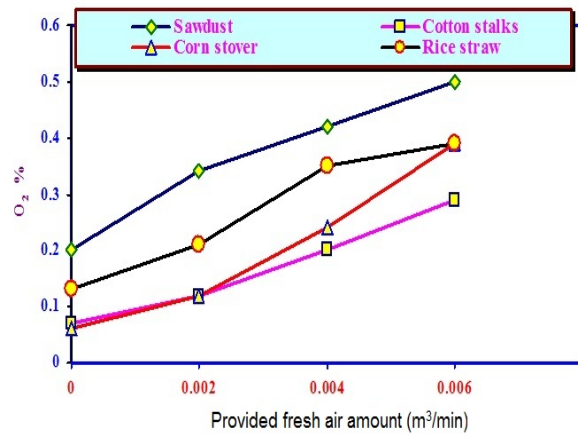

Fig. (17): O₂ percentage as affected by residues type and provided air (m³/min) using small portion size.

REFERENCES

- Chen, G., J. Andries, and H. Spliethoff, (2003).Catalytic pyrolysis of biomass for hydrogen rich fuel gas production. *Energy Conversion and Management.*, 44: 2289-2296.
- Crutzen P.J. and M.O. Andreae (1990). Biomass burning in the tropics: impact on atmospheric chemistry and biogeochemical cycles *Science*, 250:1669-1678
- Demirbas, A. (2000). Biomass resource facilities and biomass conversion processing for fuels and chemicals, *Energy Conversion and Management*, 42:1357-1378.
- Duan, F.; X. Liu; T. Yu and H. Cachier (2004).Identification and estimate of biomass burning contribution to the urban aerosol organic carbon concentrations in Beijing, *Atmospheric Environment*, 38:1275–1282
- GIZ, (2014) "Country report on the solid waste management in Egypt". The regional solid waste exchange of information and expertise network in Mashreq and Maghreb countries. Info gate. Internet: <http://www.sweep-net.org>.
- Graboski, M. (1981).Biomass Gasification Principles and Technology, T. B. Reed, editor, *Energy Technology Review* No. 67, Noyes Data Corporation, New Jersey.
- Jameel, H., Keshwani, D., Carter, S., and Treasure, T., (2010).Thermochemical Conversion of Biomass to Power and Fuels, in *Biomass to Renewable Energy Processes*, Cheng, J. (ed), CRC Press, Florida, ss. 447-487.
- Jannasch, R.; R. Samson; A. de Maio and T.Helwig (2001). Switch grass Fuel Pellet Production In Eastern Ontario: A Market Study. *Resource Efficient Agricultural Production (REAP)– Canada*.
- Klass, D.L. (1998).Biomass for renewable energy, fuels and chemicals. Academic Press, San Diego, California, pp. 91-157 and pp. 495-542

- Matouk , A. M; S.A. Hamad; M.A. Sabbah and E.S. El-Hanafy (1981). A study of sesame capsules drying. J. of Agric. Sc. Mansoura Univ, 6: 406-426.
- Ministry of Agriculture and Land Reclamation in Egypt (2015). Statistical Year Book, Central administration for agricultural economics. Study of important indicators of the agricultural statistics. (2), 136 p.
- Radlein, D., (1999).Fast Pyrolysis of Biomass: A Handbook, pp165, CPL Press: Newbury.
- Roos, C., (2010).Clean Heat and Power Using Biomass Gasification for Industrial and Agricultural Projects, U.S. Department of Energy, ss. 1-9.
- Shaban, D. A. H. and O. M. Sawan (2010). The Utilization of Agricultural Waste as One of the environmental issues in Egypt. Journal of Applied Sciences Research, 6(8): 1116-1124.
- Sharma , A. R.; S.K. Kharol; V. S. Badarinath and D. Singh (2010).Impact of agriculture crop residue burning on atmospheric aerosol loading-a study over Punjab State, India Ann. Geophys, 28:367-379.
- Vamvuka, D.; E. Karakas; E. Kastanaki and P. Grammelis (2003).Pyrolysis characteristics and kinetics of biomass residuals mixtures with lignite. Fuel, 82:1949-1960.
- Worasuwannarak, N., Sonobe, T., Tanthapanichakoon, W. (2007).Pyrolysis behaviors of rice straw, rice husk, and corncob by TG-MS technique. Journal of Analytical and Applied Pyrolysis. 78 (2), 256-271.
- Yang, H., Yan, R., Chen, H., Lee, D.H. and Zheng, C. (2007). Characteristics of hemicellulose, cellulose and lignin pyrolysis. Fuel, 86, 1781-1788.
- Yang, S.; L.U. S. HeH; D. Chen and J. Zhu (2008).Quantification of crop residue burning in the field and its influence on ambient air quality in Suqian, China, Atmospheric Environment 42 (9), 1961-1969.
- Yuan, S., Dai, Z.H., Zhou, Z.J., et al., (2012).Rapid co-pyrolysis of rice straw and a bituminous coal in a high-frequency furnace and gasification of the residual char. Bioresour. Technol. 109, 188-197.

إمكانية توليد الطاقة الحرارية من بعض المخلفات الزراعية
عماد الدين امين عبد الله ، حسني الشبراوي المرسي وحيدر عبد الحسين شنان الفرطوسي
قسم الهندسة الزراعية - كلية الزراعة - جامعة المنصورة

تهدف هذه الدراسة إلى إمكانية توليد الطاقة الحرارية من أربع مخلفات زراعية شائعة في مصر (قش الأرز، حطب الذرة، حطب القطن ونشارة الخشب) وتتميز بالتحلل الحراري وتحديد أكفنها في إعطاء أفضل طاقة. وقد تم توليد طاقة حرارية من اربع مخلفات زراعية تمت تجربتها بجهاز الانحلال الحراري تم تصميمه في ورشة قسم الهندسة الزراعية، كلية الزراعة، جامعة المنصورة، جمهورية مصر العربية. وفي الوقت نفسه، وقد أجريت سلسلة من التجارب لمعرفة تأثير احجام مختلفة من تلك المخلفات (الكتلة الحيوية) وكميات من الهواء الداخلة على كمية الغازات الناتجة من التحلل حراري للمخلفات الاربعة تحت الدراسة. الغازات المنبعثة قدرت وحلت بواسطة اجهزة تحليل الغازات. من ناحية اخرى، قدرت النسب المئوية للغازات المنبعثة وهي %CH₄، CO₂، وO₂ والناتجة من كل مخلف زراعي. وأشارت النتائج التي تم الحصول عليها ان النسبة المئوية لغاز الميثان المنبعث من بقايا المخلفات الأربعة المختبرة اعتمدت بشكل كبير على أطوال المخلفات وكميات الهواء اعطت اعلى القيم (٧٢,٦ ، ٧٧,٥ ، ٧٩,٢ و ٧٦,٢٪) نتجت من التحلل الحراري لبقايا قش الأرز، حطب الذرة، حطب القطن ونشارة الخشب على التوالي. تم الحصول على اعلى القيم للنسبة المئوية للميثان من الطول ١٥ سم من غير كمية هواء. اما اعلى القيم للنسبة المئوية لثاني اوكسيد الكربون كانت ٢٨,١ ، ٢٥,٢ ، ٢٥,٠ و ٢٥,٣ ٪ على التوالي والتي نتجت من الطول ٢٠ سم وكمية الهواء ٠.٠٠٦ م^٣/ دقيقة. والاوكسجين ٠.٥٦ ، ٠.٥٣ ، ٠.٥١ و ٠.٥ على التوالي.